



RANDOLPH AUSTIN COMPANY

www.RandolphAustin.com

Operations Manual

Pump Series: 610

Model #610-3XX-X

- 610 Pump Head
- 130 VDC - Motor
- DC Speed Control Options
 - -1 Single Speed
 - -2 Reversible
 - -3 Local/Remote – 4-20 mA input

Randolph Austin Company
2119 FM 1626
Manchaca, Texas 78652
(512) 282-1590

Table of Contents

• General Information	Page – 3
• Pump assembly layout	Page – 4
• Exploded View of 610-PHO	Page – 5
• General Motor Specifications	Page – 6
• Basic Speed Control Specifications -1	Pages – (7-15)
• Wiring Schematic for -2 (FWD/REV) Option	Page – 16
• Wiring Schematics for -3 (Local/Remote) Option	
○ Wiring Schematic for 115 VAC, 1 Phase	Page – 17
○ Wiring Schematic for 220 VAC, 1 Phase	Page –18
○ Signal Isolation Board Specifications	Pages- (19-32)
○ Drawings for Connector pins & Specifications	Page – 33
• General Pump Flow Curve	Page – 34
• Tubing Insertion instructions	Page – 35
• General Tubing specifications and chemical resistance sheet	Pages – (36-39)

Randolph Austin Company

Peristaltic Pumps

WHY CHOOSE A PERISTALTIC PUMP?

Peristaltic pumps work by using a flexible tubing inside a raceway, which is alternately compressed by a set of rotating rollers. This flexing action insulates the materials being transferred from the moving parts of the pump. The advantages are important when transferring sterile solutions, abrasives, inks or any other fluid, which would ordinarily contaminate or destroy the internal components of a pump. Because of the action of the Randolph pump, it is an excellent choice for shear sensitive fluids and applications where fluid metering is necessary.

PERFORMANCE PARAMETERS

Several factors such as viscosity, pressure, speed, pump configuration, and tubing selection, influence the flow rate of a Randolph pump. These factors must be considered to determine the selection of a pump.

Fluids with increased viscosity will result in reduced flow rates. Careful consideration needs to be made to the distance and height of the pump relative to fluids being pumped, especially if they are viscous. The further the pump is from the source, the greater the flow loss.

The discharge pressure capabilities of the Randolph pump will vary with the type and size of tubing selected as well as the operating conditions of the pump. Excessive discharge pressure may rupture tubing or reduce the effective tubing life.

Tubing selection must consider the fluid compatibility, temperature, and pressure, which the pumping application will see. It is recommended that the tubing be immersed in the fluid to be pumped for a minimum of 24 hours as a method of determining chemical compatibility. However, there is no guarantee that tubing which passes a "soak" test will perform in the same manner inside the pump. The soak test, while providing valuable information, does not replicate the dynamic situation inside the pump.

WHY YOU SHOULD CHOOSE A RANDOLPH PERISTALTIC PUMP

Randolph pumps are manufactured to exacting tolerances with high quality materials. The rugged construction of the Randolph pump makes it an ideal choice for applications where trouble free performance is necessary.

With over forty years' experience, in peristaltic pumps, Randolph Austin Company has a proven track record of value and service to our customers.

STANDARD CONSTRUCTION

Randolph pumpheads are available in a variety of material constructions. Models 250, 500, 610, and 750 are machined from aluminum housings and use stainless steel internal components for corrosion and wear resistance. The model 880 pump is machined from an aluminum casting, and uses plated steel components for its impeller plate and shaft.

STAINLESS STEEL MODELS

Randolph Austin Company offers the 615 and 755 model pumps in a 316 stainless steel housing. This material is well suited for washdown applications. Model 615 and 755 pumps have the same performance characteristics as the standard model 610 and 750 pumps respectively.

PLASTIC PUMP HEADS.

The 300 and 400 series pumps housings are made from polycarbonate. These pumps offer the O.E.M. cost effective, quality units to incorporate into their design. The 300 series pump is designed to mount directly of motor and can be configured in a variety of forms. The 400 series pump is a panel mount pump with a standard three-impeller roller yoke and hinged side cover. The 400 series is the newest pump in the Randolph Austin catalog.

THE INFORMATION CONTAINED IN THIS DRAWING IS THE SOLE PROPERTY OF Randolph Austin Company. ANY REPRODUCTION IN PART OR WHOLE WITHOUT THE WRITTEN PERMISSION OF Randolph Austin Company IS PROHIBITED.

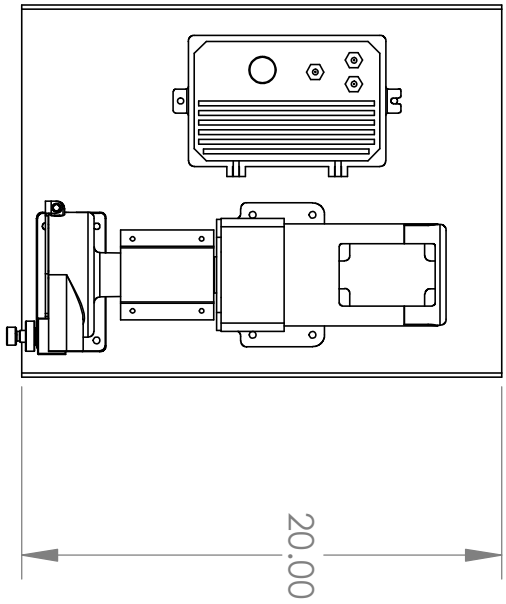
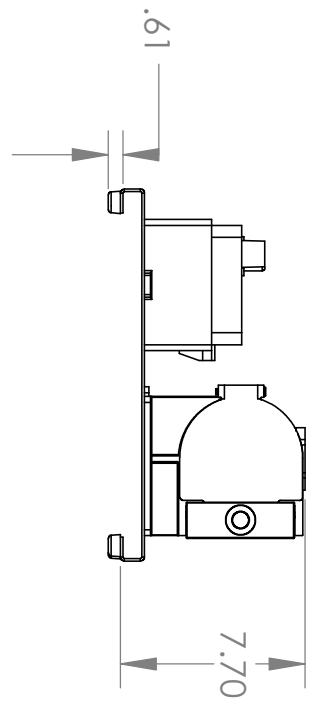

Pump Model Nomenclature

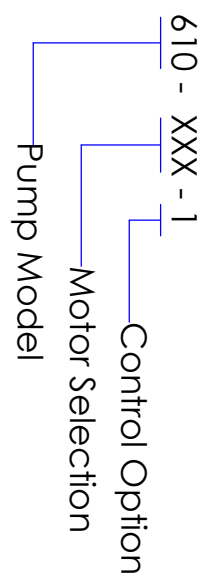

Pump Model	Motor Spec
610-342	4 - 165 RPM
610-352	6 - 250 RPM
610-362	12 - 500 RPM
610-332	3 - 125 Rpm

Control Option	Description
-1	Nema 4 Enclosure, On/OFF, Single Direction, Manual Speed Regulation
-2	Nema 4 Enclosure, FWD/REV Switch, On/OFF, Manual Speed Control
-3	Nema 4 Enclosure, FWD/REV Switch, On/OFF, Local/Remote selector, Manual Speed Pot, 4-20 mA Input Signal

Rev	Description	By	Date
-	-	-	-
-	-	-	-

APPLY	USED ON
APPLICATION	

ITEM NO.	PART OR IDENTIFYING NO.	QUANTITY	DESCRIPTION	MATERIAL SPECIFICATION	QTY RECD
UNLESS OTHERWISE SPECIFIED DIMENSIONS ARE IN INCHES TOLERANCES ARE: FRACTIONS DECIMALS ANGLES +/- 1/64 .XX +/- .01 + 1 .XXX +/- .005					
CAD GENERATED DRAWING, DO NOT MANUALLY UPDATE					
APPROVALS		DATE			
DRAWN		CHECKED			
MFG ENG		RESP ENG			
QUAL ENG		MATERIAL			
DO NOT SCALE DRAWING		FINISH			

610 Variflow - General Layout

610-3XX-X

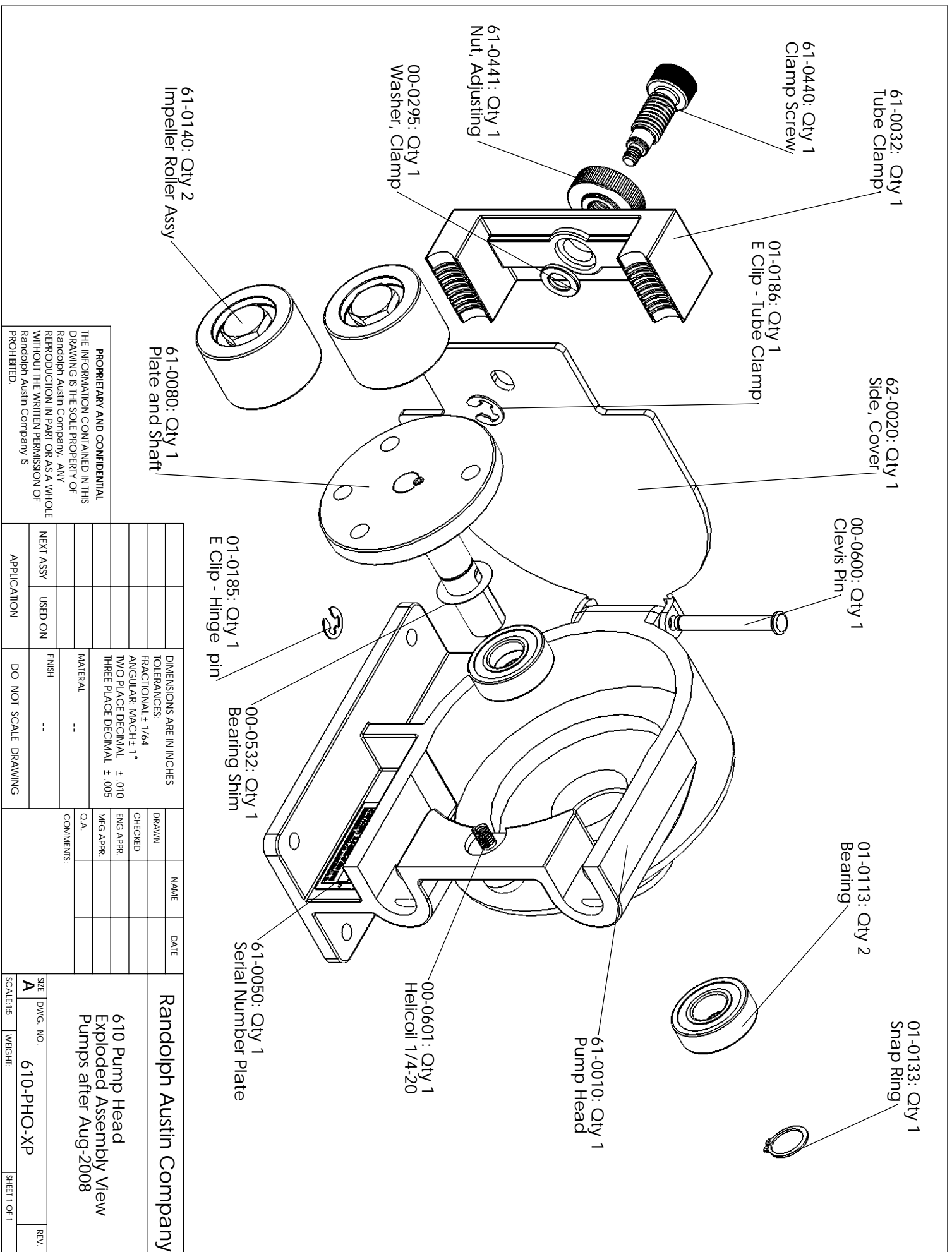

61-0032: Qty 1 Tube Clamp		62-0020: Qty 1 Side, Cover		00-0600: Qty 1 Clevis Pin		01-0133: Qty 2 Bearing		01-0133: Qty 1 Snap Ring	
61-0440: Qty 1 Clamp Screw		01-0186: Qty 1 E Clip - Tube Clamp		00-0532: Qty 1 Bearing Shim		01-0113: Qty 2 Bearing		01-0133: Qty 1 Snap Ring	
61-0441: Qty 1 Nut, Adjusting		00-0295: Qty 1 Washer, Clamp		01-0185: Qty 1 E Clip - Hinge pin		00-0601: Qty 1 Helicoil 1/4-20		01-0113: Qty 2 Bearing	
61-0140: Qty 2 Impeller Roller Assy		61-0080: Qty 1 Plate and shaft		00-0532: Qty 1 Bearing Shim		00-0601: Qty 1 Helicoil 1/4-20		01-0113: Qty 2 Bearing	
61-0050: Qty 1 Serial Number Plate		01-0185: Qty 1 E Clip - Hinge pin		00-0601: Qty 1 Helicoil 1/4-20		00-0601: Qty 1 Helicoil 1/4-20		01-0113: Qty 2 Bearing	
61-0010: Qty 1 Pump Head		62-0020: Qty 1 Side, Cover		00-0600: Qty 1 Clevis Pin		01-0133: Qty 2 Bearing		01-0133: Qty 1 Snap Ring	

PROPRIETARY AND CONFIDENTIAL
 THE INFORMATION CONTAINED IN THIS DRAWING IS THE SOLE PROPERTY OF Randolph Austin Company. ANY REPRODUCTION IN PART OR AS A WHOLE WITHOUT THE WRITTEN PERMISSION OF Randolph Austin Company IS PROHIBITED.

DIMENSIONS ARE IN INCHES TOLERANCES: FRACTIONAL ± 1/64 ANGULAR MACH ± 1° TWO PLACE DECIMAL ± .010 THREE PLACE DECIMAL ± .005	DRAWN: CHECKED: ENG APPR: MFG APPR: Q.A.	NAME: DATE:	610 Pump Head Exploded Assembly View Pumps after Aug-2008		
FINISH: --	COMMENTS:		SIZE: A	DWG. NO.: 610-PHO-XP	REV.:
APPLICATION:	USED ON:	DO NOT SCALE DRAWING	SCALE: 1:1	WEIGHT:	SHEET 1 OF 1

Randolph Austin Company

TABLE OF CONTENTS

Section	Page
I. Safety Warning	1
1. Introduction	1
II. Simplified Operating Instructions	2
III. Wiring Instructions	6
IV. Setting Selectable Jumpers	9
V. Mounting Instructions	12
VI. Operation	12
VII. AC Line Fusing	13
VIII. Trimpot Adjustments	13
IX. Diagnostic LEDs	14
X. Optional Accessories	15
XI. Limited Warranty	16
Tables	
1. Electrical Ratings	3
2. General Performance Specifications	3
3. Terminal Block Wiring Information	6
4. Field Connection (Shunt Wound Motors Only)	7
5. Setting Motor Current (SCR & PWM Motor Horsepower Ratings)	10
Figures	
1. Control Layout	4
2. Mechanical Specifications	5
3. Power Connection	6
4. Full Voltage Field	7
5. Half Voltage Field	7
6. Remote Potentiometer	7
7A. Remote 3-Wire Start/Stop Switch with Normally Open Start Contact and Normally Open Stop Contact	8
7B. Remote 3-Wire Start/Stop Switch with Normally Open Start Contact and Normally Closed Stop Contact	8
7C. Remote 2-wire Start/Stop Switch with Normally Open Start/Stop Contact	8
8. Start/Stop Function Eliminated (Jumper Installed)	8
9. Voltage Following	8
10. Inhibit Circuit	9
11. Enable Connection	9
12. Enable Circuit Using Potentiometer	9
13. DC Tach-Generator	9
14. Motor Voltage Selection (J1)	10
15. Motor Current Selection (J2)	10
16. Removing Resistor R35 (for low current selection)	10
17. Current Limit Mode Selection (J3)	11
18. DC Tach-Generator Voltage Selection (J4)	11
19. DC Tach-Generator with Addition of Rt	12

20. Run Relay Output Mode Selection (J5)	12
21. Stop Switch Type Selection (J6)	12
22. Enable Selection	12
23. ACCEL Trimpot Range	13
24. DECEL Trimpot Range	13
25. MAX Trimpot Range	13
26. MIN Trimpot Range	13
27. JOG Trimpot Range	14
28. CL Trimpot Range	14
29. TCL Trimpot Range	14
30. IR Trimpot Range	14



Electrical Hazard Warning Symbol: Failure to observe this warning could result in electrical shock or electrocution.



Operational Hazard Warning Symbol: Failure to observe this warning could result in serious injury or death.

1. SAFETY WARNING! Please read carefully

This product should be installed and serviced by a qualified technician, electrician, or electrical maintenance person familiar with its operation and the hazards involved. Proper installation, which includes wiring, mounting in proper enclosure, fusing or other overcurrent protection, and grounding can reduce the chance of electrical shocks, fires, or explosion in this product or products used with this product, such as electric motors, switches, coils, solenoids, and/or relays. Eye protection must be worn and insulated adjustment tools must be used when working with control under power. This product is constructed of materials (plastics, metals, carbon, silicon, etc.) which may be a potential hazard. Proper shielding, grounding, and filtering of this product can reduce the emission of radio frequency interference (RFI) which may adversely affect sensitive electronic equipment. If further information is required on this product, contact the factory. It is the responsibility of the equipment manufacturer and individual installer to supply this Safety Warning to the ultimate end user of this product. (SW effective 11/1992.)

This control contains electronic Start/Stop circuits that can be used to start and stop the control. However these circuits are never to be used as safety disconnects since they are not fail-safe. Use only the AC line for this purpose.

Be sure to follow all instructions carefully. Fire and/or electrocution can result due to improper use of this product.

⚠ PMW Safety Warning! This control contains a safety circuit which is designed to prevent full speed runaway in the event the main power transistor fails. However, this safety circuit is not infallible and may itself fail to operate and therefore allow a full speed runaway condition to exist. The installer of this product should take proper precautions to include other means to protect the operator or the machine involved (such as mechanical disconnects, warning notices, etc.).



This product complies with all CE directives pertinent at the time of manufacture. Contact the Sales Department for detailed installation and Declaration of Conformity. Installation of a CE approved RFI filter (KBRF-2000A [P/N 9945C] or equivalent) is required. Additional shielded motor cable and/or AC line cables may be required along with a signal isolator (KBSI-240D [P/N 9431] or equivalent).

I. INTRODUCTION

Thank you for purchasing the KBPW-240D. KB Electronics, Inc. is committed to providing total customer satisfaction by producing quality products that are easy to install and operate. The KBPW-240D is manufactured with surface mount components incorporating advanced circuitry and technology.

The KBPW-240D is a Pulse Width Modulated (PWM) control in a NEMA-4X / IP-65 watertight and washdown enclosure designed to operate PWM and SCR rated Permanent Magnet and Shunt Wound motors ranging from 0.2 Amps DC to 7.5 Amps DC. It operates at a switching frequency greater than 16KHz to provide high motor efficiency and quiet operation. **Special circuitry automatically accepts AC line input voltages of 115 Volts AC to 208/230 Volts AC (#10%, 50/60Hz) without having to make a jumper selection.**

Standard panel mounted features include diagnostic LEDs (power on, stop, and overload), Start/Stop switch, and speed potentiometer. Other features include barrier terminal blocks (facilitate wiring of AC line, motor armature, motor field, tach-generator and run relay connections), adjustable tripnops (acceleration, deceleration, maximum speed, minimum speed, jog speed [used with optional Run/Log switch], current limit, timed current limit and IR Comp.)

Optional accessories include On/Off AC Line Switch, FWD-BRK-REV Switch, Run-Stop-Jog Switch, Signal Isolator, and Anti-Plug Reversing Module. Quick-connect terminals are provided for easy installation of all optional accessories. The control is available in black finish (P/N 8401) and FDA approved white finish (P/N 8402).

STANDARD FEATURES

- **Short Circuit Protection** – Protects control from a short circuit at motor connections.
- **Electronic Motor Burnout Protection** – Timed Current Limit shuts down the control if a prolonged overload condition exists.
- **Active Bridge** – Limits the AC line inrush current when power is turned on and also prevents high speed runaway if the power transistor shorts.
- **Heat Spreader** – Allows power transistor to operate safely during momentary overload conditions.
- **Auto AC Line Select** – Control automatically adjusts for 115 or 208/230 Volt AC line input.
- **Start/Stop Switch** – Provides electronic start and stop functions.
- **Diagnostic LEDs** – For power on (ON), stop (STOP) and motor overload (OL).
- **Trimnops** – Provide adjustment for acceleration (ACCEL), deceleration (DECEL), maximum speed (MAX), minimum speed (MIN), jog speed (JOG), current limit (CL), timed current limit (TCL), and IR compensation (IR).
- **Selectable Jumpers** – Provide settings for armature voltage or tach-generator feedback (J1), motor current (J2), timed or non-timed current limit (J3), tach-generator voltage (J4), and run relay output (J5).
- **Barrier Terminal Blocks** – Facilitate wiring of AC line, motor armature and field, tach-generator, run relay output, and thermal or enable switch.
- **Quick-Connect Terminals** – Facilitate connecting Start/Stop switch, Run-Stop-Jog switch, FWD-BRK-REV switch, and Inhibit switch.

II. SIMPLIFIED OPERATING INSTRUCTIONS

IMPORTANT – You must read these simplified operating instructions before proceeding. These instructions are to be used as a reference only and are not intended to replace the detailed instructions provided herein. You must read the Safety Warning, on page 1, before proceeding.

- A. Power Connection** – Connect the AC line to L1 and L2 terminals of TB1 and the ground wire (Earth) to the green ground screw as shown in Figure 3, on page 6, and as described in Section IIIA, on page 6, and Section IIIB, on page 6.
- B. Permanent Magnet (PM) Motor Connection (Two-Wire Type)** – Connect the motor armature to A1 (+) and A2 (-) terminals of TB1 as shown in Figure 3, on page 6, and as described in Section IIIC, on page 6. Be sure that jumper J3 is set to the corresponding motor voltage position as described in Section IVA, on page 10. **Do not use F1 and F2 terminals of TB2 for any purpose other than to power the field of a shunt wound motor. Do not use F1 and F2 terminals for PM motors.**
- Note:** Motor performance and efficiency, including brush life, may be adversely affected when operating the control in stepdown mode (208/230 Volt AC line with 90/130 Volt DC motors).
- C. Shunt Wound Motors (Four-Wire Type)** – Connect the motor armature as described in Section IIIC, on page 6. Connect full voltage field wires (90 Volt DC motors with 100 Volt DC field and 180 Volt DC motors with 200 Volt DC field) to F1 (+) and F2 (-) terminals of TB2 as described in Section IIID, on page 7. Connect half voltage field wires (90 Volt DC motors with 50 Volt DC field and 180 Volt DC motors with 100 Volt DC field) to F1 (+) terminal of TB2 and L1 (-) terminal of TB1 as described in Section IIIE, on page 7.
- Note:** Do not connect motor armature leads to F1 and F2 terminals.

- D. Motor Current** – Jumper J2 is factory set for 7.5 Amp motors. For lower current motors, set jumper J2 to the corresponding motor current as described in Section IVB, on page 10.
Note: The factory setting for Current Limit is 150% of the nominal current setting (example: if jumper J2 is set to "5A", position, the CL trimpot is calibrated for 7.5 Amps).
- E. Trimpot Settings** – All trim pots have been factory set as shown in Figure 1, on page 4. Trim pots may be readjusted as described in Section VIII, on page 13.
- F. Diagnostic LEDs** – After power has been applied, observe the LEDs to verify proper control function as described in Section IX, on page 14.
- G. Start/Stop Switch** – The control is supplied with a prewired Start/Stop switch as described in Section III G, on page 7. This switch must be used to start the control each time the AC power is lost or the control shuts down due to T.C.L. To override this function, see Section III G, on page 7.

TABLE 1 – ELECTRICAL RATINGS

AC Line Voltage (±10%, 50/60 Hz) (Volts AC)	Motor Voltage (Volts DC)	Maximum AC Line Current (Amps RMS)	Maximum Load Current (Amps DC)	Maximum Horsepower		Field Voltage (Volts DC)
				SCR Rated Motors	PWM Rated Motors	
115	0 - 90, 130	11.5	7.5	3/4, (0.5)	1, (0.75)	100
208 - 230	0 - 180, 260	11.5	7.5	1½, (1)	2, (1.5)	200

TABLE 2 – GENERAL PERFORMANCE SPECIFICATIONS

Parameter	Specification	Factory Setting
Operating Frequency (KHz)	>16	-
Operating Temperature Range at Full Rating (°C)	0 - 50	-
Current Range (High Scale) (Amps DC)	1.7, 2.5, 3.5, 5.0, 7.5	7.5
Current Range (Low Scale) (Amps DC) ¹	0.2, 0.3, 0.4, 0.5, 0.8	-
ACCEL and DECEL Range (Seconds)	0.5 - 10	1
Jog Speed (% Base Speed)	0 - 50	15
MIN Speed Range (% Base Speed [90VDC & 180VDC Motors])	0 - 30	0
MAX Speed Range (% Base Speed [90VDC & 180VDC Motors])	50 - 140	100
IR Comp Range at 90 Volts DC Output (ΔVolts DC at Full Load)	0 - 15	4
IR Comp Range at 180 Volts DC Output (ΔVolts DC at Full Load)	0 - 30	8
CL Range (% Range Setting)	0 - 200	150
Timed Current Limit (TCL) Range (Seconds)	0.5 - 10	5
AC Line Input Voltage (Volts AC, ±10%, 50/60 Hz)	115 - 208/230	-
AC Line Regulation (% Base Speed)	0.5	-
Armature Voltage Range at 115 Volts AC Line Input (Volts DC)	0 - 130	90
Armature Voltage Range at 208/230 Volts AC Line Input (Volts DC)	0 - 130 ² - 0 - 260	90
Armature Feedback Load Regulation (% Base Speed)	1	-
Tach-Generator Feedback Load Regulation (% Set Speed)	1	-
Field Voltage at 115 Volts AC Line Input (Volts DC)	100/50	-
Field Voltage at 208/230 Volts AC Line Input (Volts DC)	200/100	-
Speed Range (Ratio)	50:1	-
Voltage Following Linearity (% Base Speed)	±0.5	-

¹ For low current operation, remove resistor R35 as described in section IVB, on page 10
² Step-down operation
³

FIGURE 1 – CONTROL LAYOUT
 (Illustrates Factory Setting of Jumpers and Approximate Trim pot Settings)

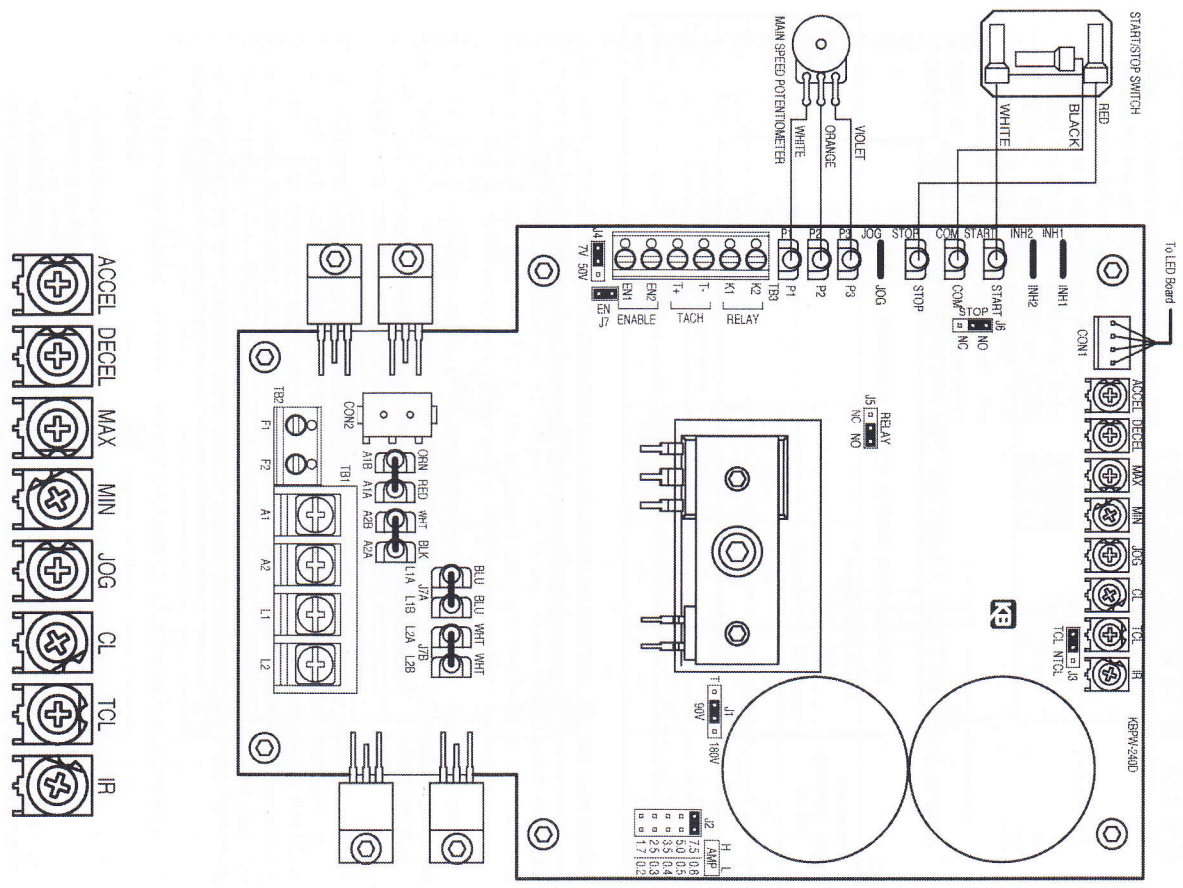

Enlarged view of trim pots

FIGURE 2 – MECHANICAL SPECIFICATIONS (INCHES / mm)

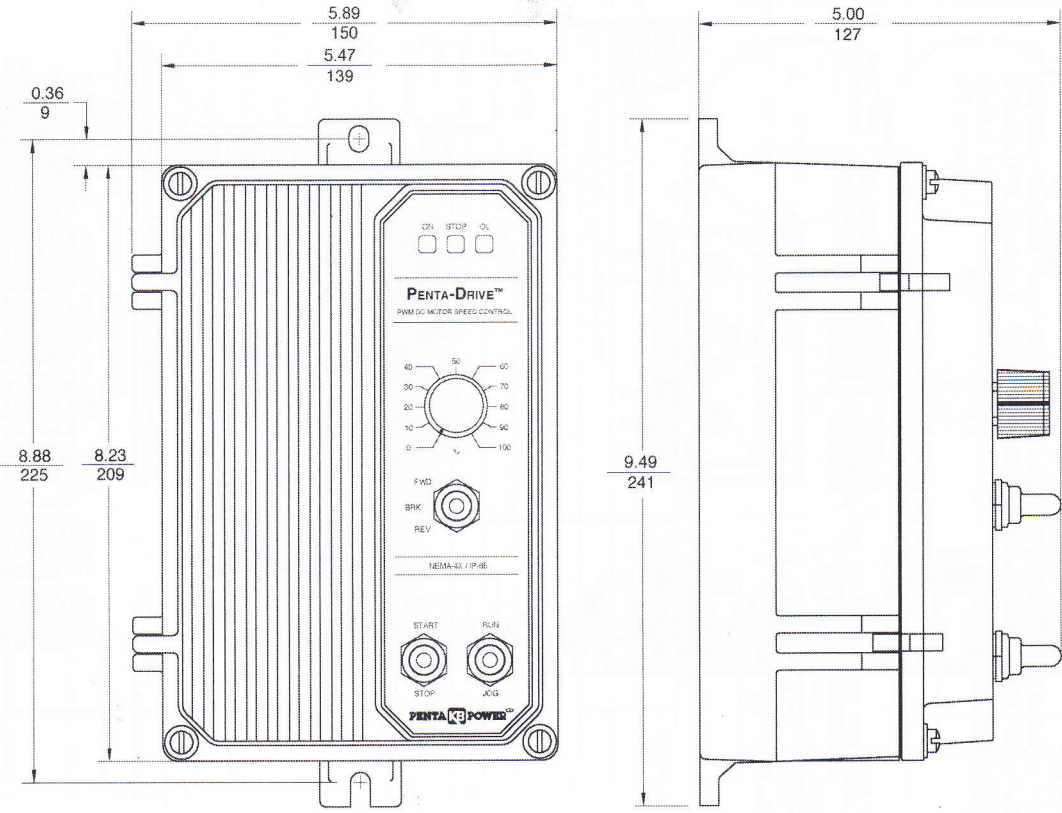

CONTROL SHOWN WITH OPTIONAL FWD-BRK-REV AND RUN-STOP-JOG SWITCHES

III. WIRING INSTRUCTIONS

WARNING! Read Safety Warning, on page 1, before using this control. Disconnect the AC line before wiring.

Note: To avoid erratic operation, do not bundle AC line and motor wires with wires from signal following, start/stop switch, inhibit, or any other signal wires. Use shielded cables on all signal wiring over 12" (30cm). Shield should be Earth grounded on the control side only. Wire the control in accordance with the National Electrical Code requirements and other codes that may apply to your area. See Figure 3, Table 3 and Table 4, on page 7.

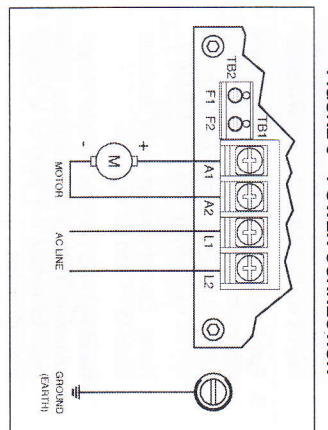

FIGURE 3 – POWER CONNECTION

TABLE 3 – TERMINAL BLOCK WIRING INFORMATION

Terminal Block	Designation	Connections	Supply Wire Gauge (AWG - Cu)		Maximum Tightening Torque (in-lbs)
			Minimum	Maximum	
TB1	AC Line Input	L1 & L2	22	12	12
TB1	Motor Armature	A1 & A2	22	12	12
TB2	Motor Field (Shunt Wound Motors Only)	F1 & F2	24	14	3.5
TB3	Tach-Generator	T+ & T-	24	14	3.5
TB4	Fun Relay	K1 & K2	24	14	3.5

Be sure to properly fuse each conductor that is not at ground potential. **Do not fuse neutral or grounded conductors.** See Section VII, on page 13. A separate AC line switch or conductor must be wired as a disconnect so that each ungrounded conductor is opened. An accessory On/Off AC Line Switch (P/N 9341) may be used in lieu of, or in addition to, the Start/Stop switch. The switch can be wired for single pole or double pole operation, as required.

To maintain the watertight integrity of the control, be sure to use suitable watertight connectors and wiring which are appropriate for the application. Two 7/8" (22.2mm) knockout holes are provided for standard 1/2" knockout connectors (not supplied) for wiring. A watertight plug is provided if only one knockout is required.

Warning! Do not wire switches or relays in series with the armature. Armature switching can cause catastrophic failure of motor and/or control. To avoid erratic operation, do not bundle AC line and motor wires with potentiometer wires, voltage following wires, Start/Stop switch wires, inhibit wires, or any other signal wires. Use shielded cables on all signal wiring over 12" (30cm) long. Shield should be Earth grounded on the control side only. **Warning! Do not use CON2 for any purpose other than to power the optional Anti-Plug Reversing Module APRM-PC (P/N 9378A).**

A. AC Line Connection – Wire AC line input to L1 and L2 terminals of TB1 as shown in Figure 3.

B. Ground Connection – Earth ground the control chassis using the green ground screw that is provided on the inside of the control to the right side of TB1 as shown in Figure 3.

C. Permanent Magnet (PM) Motor Connection – Wire the motor armature leads to A1 (+) and A2 (-) terminals of TB1 as shown in Figure 3. Be sure jumper J1 is set to the appropriate motor voltage and that J3 is set to the appropriate motor current. For step-down operation (230 Volt AC line input with 90 Volt DC SCR rated motor or 130 Volt DC PWM rated motor) set jumper J1 to "90V" position. However, in step-down operation the motor may have reduced brush life - consult motor manufacturer.

Note: Do not connect motor armature leads to F1 and F2 terminals. Do not use F1 and F2 terminals for PM motors.

D. Full Voltage Field Connection (Shunt Wound Motors Only) – Wire the motor field leads to F1 (+) and F2 (-) terminals of TB2 as shown in Figure 4 & Table 4.

Note: Do not connect motor armature leads to F1 and F2 terminals.

Warning! Do not use F1 and F2 terminals of TB2 for any purpose other than to power the field of a shunt wound motor.

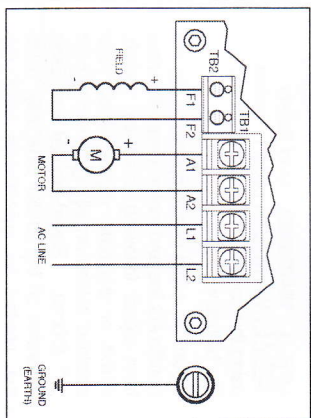

FIGURE 4 – FULL VOLTAGE FIELD

E. Half Voltage Field Connection (Shunt Wound Motors Only) – Wire the motor field leads to F1 (+) and L1 (-) terminals of TB2, as shown in Figure 5 & Table 4.

Note: Do not connect motor armature leads to F1 and F2 terminals.

Warning! Do not use F1 and F2 terminals of TB2 for any purpose other than to power the field of a shunt wound motor.

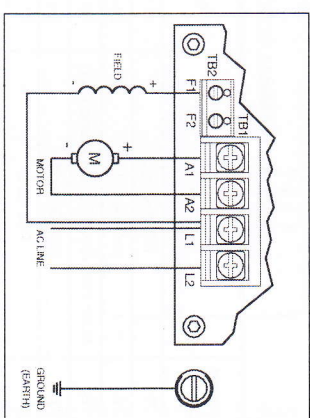

FIGURE 5 – HALF VOLTAGE FIELD

AC Line Voltage (Volts AC)	Armature Voltage (Volts DC)	Field Voltage (Volts DC)	Field Connections
115	90 – 130	100	F1 & F2
115	90 – 130	50	F1 & L1
230	180 – 260	200	F1 & F2
230	180 – 260	100	F1 & L1
230	90 – 130	100	F1 & L1

TABLE 4 – FIELD CONNECTION (Shunt Wound Motors Only)

F. Remote Main Speed Potentiometer

Connection – The control is supplied with a prewired main speed potentiometer mounted on the front cover. To operate the control from a remote potentiometer (5K Ω), remove the white, orange, and violet potentiometer leads from P1, P2, and P3 terminals, respectively. The leads may be taped and left inside the control. The potentiometer assembly may be removed if a watertight seal is used to cover the hole in the front cover. Connect the remote main speed potentiometer wires to terminals P1 (low side), P2 (wiper), and P3 (high side) as shown in Figure 6.

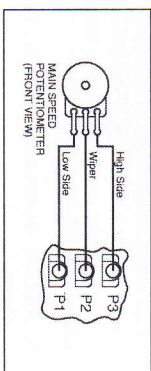

FIGURE 6 – REMOTE POTENTIOMETER

G. Remote Start/Stop Switch Connections

– The control is supplied with a prewired Start/Stop switch mounted on the front cover. To operate the control from a remote Start/Stop switch (type: (ON)-OFF-ON, (SPDT)), remove the white, black, and red wires from START, COM, and STOP terminals, respectively. The leads may be taped and left in the control. The switch itself may be removed if a watertight seal is used to cover the hole

in the front cover. Connect the remote Start/Stop switch wires to START (momentary), COM (common), and STOP (constant) terminals as shown in Figure 7A.

After applying power, momentarily set the Start/Stop switch to "START" position. The motor will operate at the set speed of the main speed potentiometer. To stop the motor, set the Start/Stop switch to "STOP" position.

For remote 3-wire Start/Stop Switch with normally open start contact and normally closed stop contact, see Figure 7B.

For remote 2-wire Start/Stop Switch with normally open start/stop contact, see Figure 7C.

Note: For automatic start when power is applied, the Start/Stop function can be bypassed. This can be accomplished by installing a jumper (provided with control) between the START and COM terminals. Jumper J5 must be in the "NO" position. See Figure 8.

CAUTION! Eliminating the Start/Stop function using a jumper will cause the motor to run at the main speed potentiometer setting when the AC line is applied.

H. Run Relay Connection

– Normally open (NO) or normally closed (NC) relay output contacts are provided at TB4, which will change state when the Start/Stop switch is set to "START" position or if the control shuts down and goes into STOP mode from TCL. The run relay is used to indicate the state of the control (run or stop). Normally open or normally closed run relay contact outputs can be selected depending on the position of jumper J5. If normally open is selected (J5 in "NO" position), the run relay output contacts will close when the Start/Stop switch is set to "START" position. If normally closed is selected (J5 set to "NC" position), the run relay output contacts will open when the Start/Stop switch is set to "START" position. When the control shuts down and goes into STOP mode from TCL, or the Start/Stop switch is set to "STOP" position, the Run Relay output contacts will return to their normal position.

FIGURE 7A – REMOTE 3-WIRE START/STOP SWITCH WITH NORMALLY OPEN START CONTACT AND NORMALLY CLOSED STOP CONTACT

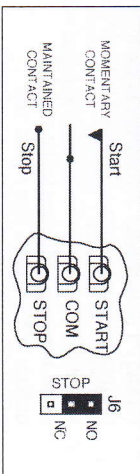

FIGURE 7B – REMOTE 3-WIRE START/STOP SWITCH WITH NORMALLY OPEN START CONTACT AND NORMALLY CLOSED STOP CONTACT

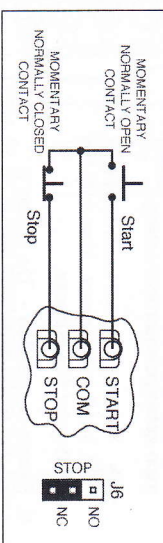

FIGURE 7C – REMOTE 2-WIRE START/STOP SWITCH WITH NORMALLY OPEN START/STOP CONTACT

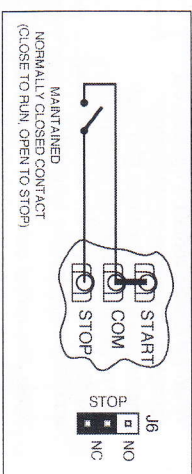

FIGURE 8 – START/STOP FUNCTION ELIMINATED (JUMPER INSTALLED)

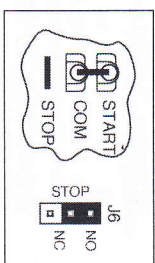
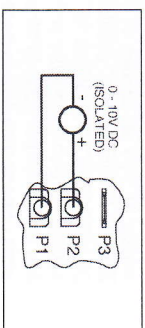

FIGURE 9 – VOLTAGE FOLLOWING



Note: If relay output contacts are not required for your application, J5 may be in any position.

1. Voltage Following Connection – An isolated 0 - 10 Volt DC analog signal can also be used to control motor speed. See Figure 9.

Note: If an isolated signal voltage is not available, an optional signal isolator can be installed (KBSI-240D, P/N 9431). Connect the isolated signal voltage to P2 (+) and P1 (-) terminals. Adjustment of the MIN trim-pot may be necessary to achieve a 0 Volt DC output.

J. Inhibit Connection – The control is supplied with inhibit terminals (INH1 and INH2) to connect an Inhibit switch. See Figure 10.

These terminals are used to electronically stop the control. When the Inhibit switch is closed, the control will coast to stop. When the Inhibit switch is opened, the control will accelerate to the main speed potentiometer setting.

Warning! Do not use Inhibit as a safety disconnect. Use only the AC line for this purpose.

K. Enable Connection – The Enable is used to electronically start and stop the control. When the Enable contact is closed, the control will accelerate to the Main Speed Potentiometer setting. When the Enable contact is opened, the control will coast to stop. Wire the Enable contact to Terminals EN1 and EN2 of Terminal Block TB3 as shown in Figure 11. The contacts must be isolated and Jumper J7 must be removed.

Note: The control can also be started and stopped with an Enable contact in the Main Speed Potentiometer circuit. The Enable function is established by wiring a switch in series with the violet Main Speed Potentiometer lead which connects to the P3 terminal. See Figure 12.

Warning! Do not use Enable as a safety disconnect. Use only the AC line for this purpose. The Enable Circuit is not isolated and is not to be Earth grounded.

L. DC Tach-Generator Connection – Wire the tach-generator to T+ (+) and T- (-) terminals of TB4 as shown in Figure 13. Jumper J1 must be in "T" position. Jumper J4 must be in "TV" position for 7 Volt per 1000 RPM tach-generators or "50V" position for 50 Volt per 1000 RPM tach-generators. See section IVD on page 11.

Note: When using a tach-generator, the IR trimpot should be set fully counterclockwise.

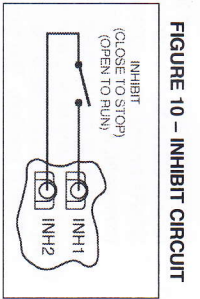

FIGURE 10 – INHIBIT CIRCUIT

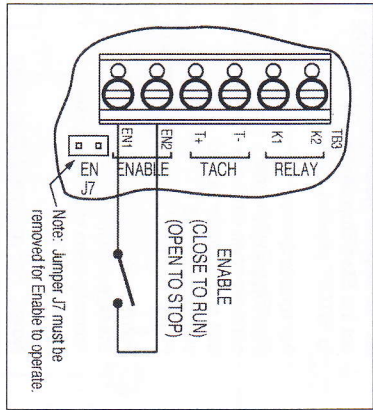

FIGURE 11 – ENABLE CONNECTION

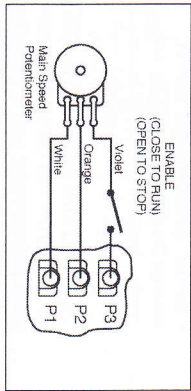

FIGURE 12 – ENABLE CIRCUIT USING POTENTIOMETER

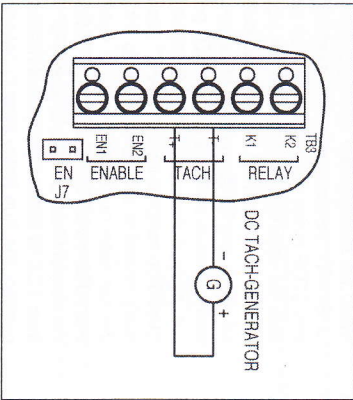

FIGURE 13 – DC TACH-GENERATOR

A. Motor Voltage Selection (J1) – Jumper J1 is factory set to "90V" position for 90 Volt SCR rated motors (or 130 Volt PWM rated motors). For 180 Volt SCR rated motors (or 220 Volt PWM rated motors), set Jumper J1 to "180V" position. See Figure 14.

Note: If Jumper J1 is set to "T" position, a tach-generator must be wired to TB3. If a tach-generator is not used, Jumper J1 must be in either "90V" or "180V" position. If Jumper J1 is in "T" position and a tach-generator is not used, the motor will accelerate to full speed and the main speed potentiometer will not control speed.

B. Motor Current Selection (J2) –

Jumper J2 is factory set to "7.5A" position for 7.5 Amp motors. For motors of lower amperage, set Jumper J2 to the corresponding position for the motor being used. See Figure 15 and Table 5.

Note: For low (L) motor current settings (0.8A, 0.5A, 0.4A, 0.3A, and 0.2A), it is necessary to remove resistor R35. Cut the leads at the locations shown in Figure 16.

WARNING! Disconnect AC line before cutting out resistor R35. Use an insulated cutter and wear safety glasses.

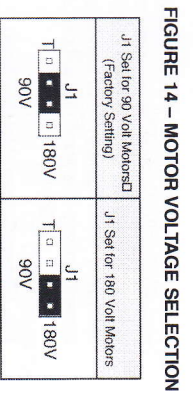

FIGURE 14 – MOTOR VOLTAGE SELECTION

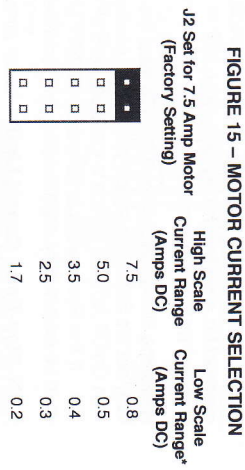

FIGURE 15 – MOTOR CURRENT SELECTION

Note: For low (L) motor current range settings (0.8A, 0.5A, 0.4A, 0.3A and 0.2A), it is necessary to remove resistor R35 by cutting it out of the circuit as shown in Figure 16 on page 10.

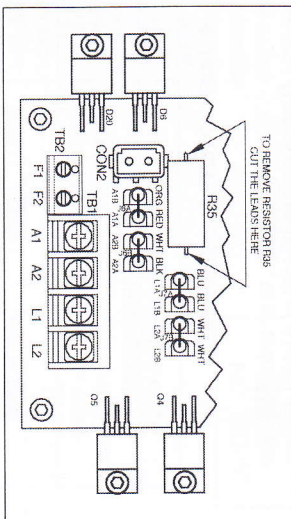

FIGURE 16 – REMOVING RESISTOR R35

TABLE 5 – SETTING MOTOR CURRENT (SCR & PWM Motor Horsepower Ratings)

J2 Setting (Amps DC)	SCR Rated Motor Horsepower HP (KW)		PWM Rated Motor Horsepower HP (KW)	
	90 Volts DC Motors	180 Volts DC Motors	130 Volts DC Motors	220Volts DC Motors
7.5	3/4, (0.5)	1 1/2, (1)	1, (0.75)	2, (1.5)
5.0	1/2, (0.37)	1, (0.75)	3/4, (0.5)	1 1/2, (1)
3.5	1/3, (0.25)	3/4, (0.5)	1/2, (0.37)	1, (0.75)
2.5	1/4, (0.18)	1/2, (0.37)	1/3, (0.25)	3/4, (0.5)
1.7	1/6, (0.1)	1/3, (0.25)	1/4, (0.18)	1/2, (0.37)
0.8*	1/12, (0.06)	1/6, (0.1)	1/8, (0.09)	1/4, (0.18)
0.5*	1/20, (0.04)	1/10, (0.08)	1/15, (0.05)	1/6, (0.1)
0.4*	1/25, (0.03)	1/12, (0.06)	1/20, (0.04)	1/8, (0.09)
0.3*	1/30, (0.02)	1/15, (0.05)	1/25, (0.03)	1/10, (0.08)
0.2*	1/50, (0.01)	1/25, (0.03)	1/30, (0.02)	1/20, (0.04)

Note: For low (L) motor current range settings (0.8A, 0.5A, 0.4A, 0.3A and 0.2A), it is necessary to remove resistor R35 as shown in Figure 16.

IV. SETTING SELECTABLE JUMPERS

The KBPV-240D has customer selectable jumpers which must be set before the control can be used. See Figure 1, on page 4 for location of jumpers.

C. Timed and Non-Timed Current Limit Selection (J3) – Jumper J3 is factory set to “TCL” position for timed current limiting operation. See Figure 17. For non-timed current limiting operation, set Jumper J3 to “NTCL” position.

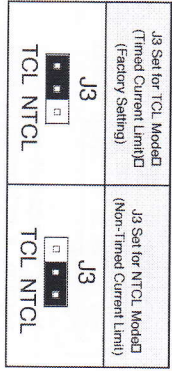

FIGURE 17 – CURRENT LIMIT MODE SELECTION

TCL (Timed Current Limit) – When Jumper J3 is in the “TCL” position, the control will go into “STOP” after it is in overload for a predetermined amount of time (set by the TCL trimpot).

Resetting the Control After TCL – To reset the control after it has gone into TCL, momentarily set the Start/Stop switch to “START” position or disconnect and reconnect the AC line. If an On/Off AC Line Switch is installed, set it to “OFF” position and then back to “ON” position. If the Start switch is jumpered (START and COM terminals connected), the control must be restarted by disconnecting and reconnecting the AC line.

NTCL (Non-Timed Current Limit) – When jumper J3 is set to “NTCL” position, the control will not go into “STOP” after it is in overload.

Note: TCL trimpot will have no affect when jumper J3 is in “NTCL” position.

D. DC Tach-Generator Voltage Selection (J1 and J4) – For a tach-generator wired to TB3, set Jumper J1 to “V” position. See Figure 18. Jumper J4 is factory set to “7V” position for 7 Volt per 1000 RPM tach-generators wired to TB3. For a 50 Volt per 1000 RPM tach-generator, set Jumper J4 to “50V” position.

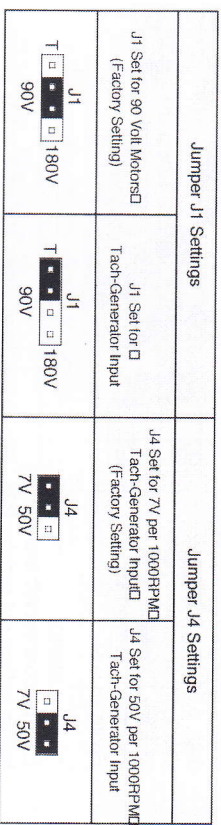

FIGURE 18 – DC TACH-GENERATOR VOLTAGE SELECTION

Note: When using a tach-generator, the IR trimpot should be set fully counterclockwise.

Note: The tach-generator input is designed for 7 Volt or 50 Volt per 1000 RPM tach-generators used with 1800 RPM motors. For tach-generators other than 7 Volt or 50 Volt per 1000 RPM or for motors other than 1800 RPM, an external 1/2 watt resistor (Rt) must be used. Install Rt in series with the tach-generator as shown in Figure 19, on page 12. Jumper J4 must be set to “V” position.

The value of Rt in Ω can be calculated using the following formula:

$$Rt = (1.46 \times Vr \times S) - 19,000$$

Where Vr is the tach-generator voltage (in Volts per 1000 RPM) and S is the base speed of the motor (in RPM).

Suppose you have a 20 Volt per 1000 RPM tach-generator with a 3600 RPM motor:
 $Rt = (1.46 \times 20 \times 3600) - 19000 = 86120\Omega$
 Choose the closest 1/2W resistor value, which is 82000 Ω (82K Ω) or 91000 Ω (91K Ω). Readjustment of the MAX trimpot may be necessary to achieve the desired maximum output voltage.

E. Run Relay Output Mode Selection (J5) – Jumper J5 is factory set to “NO” position for normally open relay output at TB4. For normally closed relay output, set Jumper J5 to “NC” position. See Figure 20.

F. Stop Switch Type Selection (J6) – Jumper J6 is factory set to the “NO” position for a normally open stop switch, as used on the front cover. If a remote normally closed stop switch is used, set Jumper J6 to the “NC” position. If a remote normally open stop switch is used, set Jumper J6 to the “NO” position. See Figure 21.

G. Enable Selection (J7) – Jumper J7 is factory installed to enable the control. If connecting Enable contacts to Terminals EN1 and EN2 of Terminal Block TB3, remove Jumper J7. See Figure 22.

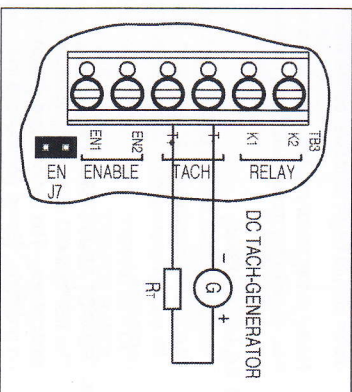

FIGURE 19 – DC TACH-GENERATOR WITH ADDITION OF Rt

V. MOUNTING INSTRUCTIONS

Warning! The KBPW-240D is not designed to be used in an explosion-proof application.

It is recommended that the control be mounted vertically on a flat surface with adequate ventilation. Leave enough room below the control to allow for AC line, motor connections, and any other wiring. Although the control is designed for outdoor and wash-down use, care should be taken to avoid extreme hazardous locations where physical damage can occur. If the control is mounted in a closed, unventilated location, allow enough room for proper heat dissipation. If operating the control at full rating, a minimum enclosure size of 12”W x 24”H x 12”D is required. See Figure 2, on page 5.

The KBPW-240D is designed with a hinged case so that when the front cover is open, all wiring stays intact. To open the cover, the four screws must be loosened so they are no longer engaged in the case bottom. After mounting and wiring, close the cover and make sure that wires will not get caught or crimped as the cover is closed. Tighten all four cover screws so that the gasket is slightly compressed. **Do not over tighten.**

VI. OPERATION

Caution! It is recommended that the bus capacitors be reconditioned if this product has been in storage for over one year. To recondition the capacitors, apply the AC line, with the drive in Stop Mode, for a minimum of one hour.

After the control has been properly set up (jumpers set to desired positions and wiring completed), the startup procedure can begin. If AC power has been properly brought to the control, the ON and STOP LEDs will be illuminated. Before starting, be sure the main speed

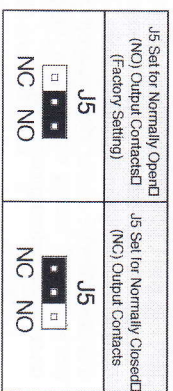

FIGURE 20 – RUN RELAY OUTPUT MODE SELECTION

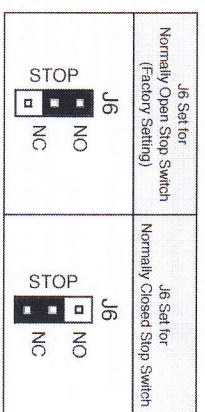

FIGURE 21 – STOP SWITCH TYPE SELECTION

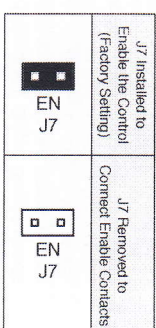

FIGURE 22 – STOP SWITCH TYPE SELECTION

potentiometer is fully counterclockwise. To start the control, momentarily set the Start/Stop switch to "START" position and release it. The STOP LED should no longer illuminate. The motor should begin to rotate, as the main speed potentiometer is rotated clockwise.

Note: If the motor rotates in the incorrect direction, it will be necessary to disconnect the AC line, reverse the motor leads, and repeat the startup procedure.

VII. AC LINE FUSING

This control does not contain AC line fuses. Most electrical codes require that each ungrounded conductor contain circuit protection. Installation of a 20 Amp fuse or circuit breaker in series with each ungrounded conductor is recommended. Check all electrical codes that apply to the application.

VIII. TRIMPOT ADJUSTMENTS

The KBPW-240D contains trimpots, which are factory set for most applications. The trimpots are shown in the approximate calibrated positions. Some applications may require readjustment of the trimpots in order to tailor the control for a specific requirement. Readjust trimpots as described below.

Warning! If possible, do not adjust trimpots with main power applied. If adjustments are made with used and safety glasses should be worn. High voltage exists in this control. Fire and/or electrocution can result if caution is not exercised. **Safety Warning, on page 1, must be read and understood before proceeding.**

A. Acceleration (ACCEL) – Sets the amount of time for the motor to accelerate from minimum speed to maximum speed. The ACCEL trimpot is factory set for one (1) second, as shown in Figure 23. For more rapid acceleration time, rotate the trimpot counterclockwise. For longer acceleration time, rotate the trimpot clockwise.

Note: Rapid acceleration settings may cause the current limit circuit to activate, which will extend the acceleration time.

B. Deceleration (DECCEL) – Sets the amount of time for the motor to decelerate from maximum speed to minimum speed. The DECCEL trimpot is factory set for one (1) second, as shown in Figure 24. For more rapid deceleration time, rotate the trimpot counterclockwise. For longer deceleration time, rotate the trimpot clockwise.

Note: Deceleration time will not be shorter than the maximum coast time of the motor under actual load.

C. Maximum Speed (MAX) – Sets maximum speed of the motor. The MAX trimpot is factory set for 100% of base motor speed, as shown in Figure 25. For a higher maximum speed setting, rotate the trimpot clockwise. For a lower maximum speed setting, rotate the trimpot counterclockwise.

D. Minimum Speed (MIN) – Sets minimum speed of the motor. The MIN trimpot is factory set for 0% speed, as shown in Figure 26. For a higher minimum speed setting, rotate the trimpot clockwise.

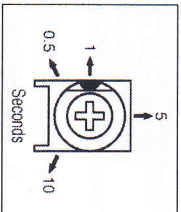

FIGURE 23 – ACCEL TRIMPOT RANGE

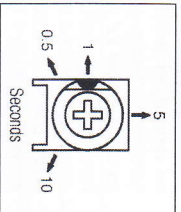

FIGURE 24 – DECCEL TRIMPOT RANGE

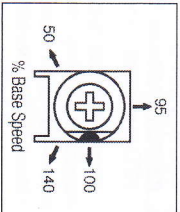

FIGURE 25 – MAX TRIMPOT RANGE

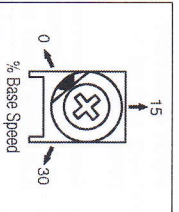

FIGURE 26 – MIN TRIMPOT RANGE

E. Jog Speed (JOG) – Sets "jog" speed of the motor. The JOG trimpot is factory set for 15% of motor base speed, as shown in Figure 27. For a higher jog setting, rotate the trimpot clockwise. For a lower jog setting, rotate the trimpot counterclockwise.

Note: The Jog feature requires installation of the Run-Stop-Jog Switch assembly (P/N 9340).

F. Current Limit (CL) – Sets current limit (overload), which limits the maximum current to the motor. The current limit set point is established by the setting of jumper J2 and the setting of the CL trimpot. The CL trimpot is factory set for 150% of J2 range setting, as shown in Figure 28. For a higher current limit setting, rotate the trimpot clockwise. For a lower current limit setting, rotate the trimpot counterclockwise. Two modes of current limiting operation are provided: Non-Timed Current Limit (NTCL) and Timed Current Limit (TCL). See Section IV.C, on page 11.

CAUTION! Adjusting the CL above 150% of motor rating can cause overheating and demagnetization of some PM motors. Consult the motor manufacturer. Do not leave the motor in a locked condition for more than a few seconds since armature damage may occur.

G. Timed Current Limit (TCL) – Sets the time for the control to shut down after being in current limit (provides electronic motor overload protection). The TCL trimpot is factory set for 5 seconds, as shown in Figure 29. For increased TCL time, rotate the trimpot clockwise. For decreased TCL time, rotate the trimpot counterclockwise. If the control remains in CL for a predetermined amount of time (set by the TCL trimpot and if jumper J3 is in the "TCL" position), the control will shut down. To reset the control after it has shut down, momentarily set the start/stop switch to the "START" position or disconnect and then reconnect the AC line.

Warning! When the control shuts down in TCL, the AC line voltage is still present in the control.

H. Non-Timed Current Limit (NTCL) – When jumper J3 is set to "NTCL" position and an overload condition exists, the control will remain in current limit and will not shut down.

I. IR Compensation (IR) – Sets the amount of compensating voltage required to keep the motor speed constant under changing loads. The IR trimpot is factory set for 4 Volts (for 90 Volt DC output) and 8 Volts (for 180 Volt DC output), as shown in Figure 30. For higher compensating voltage, rotate the trimpot clockwise. For lower compensating voltage, rotate the trimpot counterclockwise.

Note: If the IR compensation is set too high, unstable (oscillatory) operation will result. If the control is used with a tach-generator, the IR trimpot should be set fully counterclockwise.

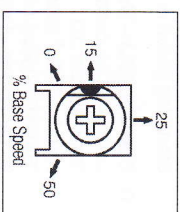

FIGURE 27 – JOG TRIMPOT RANGE

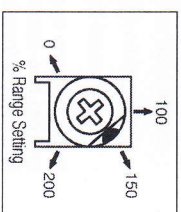

FIGURE 28 – CL TRIMPOT RANGE

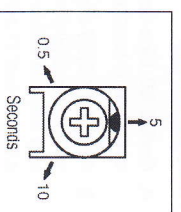

FIGURE 29 – TCL TRIMPOT RANGE

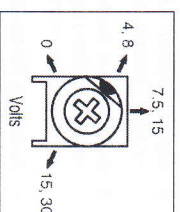

FIGURE 30 – IR TRIMPOT RANGE

IX. DIAGNOSTIC LEDs
The KBPW-240D is designed with LEDs mounted on the front cover to display the control's operational status.

A. Power On (ON) – The ON LED will illuminate green when the AC line is applied to the control.

Note: When removing power to the control, the POWER LED will remain illuminated for a few seconds until the DC bus voltage discharges.

- B. Stop (STOP)** – The STOP LED will illuminate yellow when the Start/Stop switch is set to "STOP" position. When AC line is applied, this LED will also be illuminated until the Start/Stop switch is set to "START" position.
- C. Overload (OL)** – The OL LED will illuminate red when the control goes into current limit, indicating that the current limit set point has been reached (set by the CL trimpot and the position of jumper J2). This LED will remain illuminated if the control times out in TCL (Jumper J3 set to "TCL" position). The control can be reset by either setting the start/stop switch to "START" position or by disconnecting and reconnecting the AC line. If the overload condition still exists when the control is restarted or AC line reapplied, the OL LED will illuminate again. If the OL LED remains illuminated during control operation, a fault condition may exist. Possible causes for this condition are as follows:
- Motor is overloaded. Check motor current. If the motor is a shunt wound type, the field may be open or not receiving proper voltage.
 - Motor may be defective. Check motor for shorts or grounds.
 - CL may be set too low. Check position of CL trimpot and setting of Jumper J2.

Note: In some applications, especially those requiring the motor to cycle on and off, or from one speed to another, or from stop to high speeds, the OL LED may blink, indicating a transient overload. This may be a normal condition for the application.

X. OPTIONAL ACCESSORIES

Complete instructions and connection diagrams are supplied with all accessories to facilitate installation.

- A. On/Off AC Line Switch (P/N 9341)** – Disconnects the AC line. Mounts on the enclosure cover and is supplied with a switch seal to maintain watertight integrity.
- B. FWD-BRK-REV Switch (P/N 9339)** – Provides motor reversing and dynamic braking. This switch is equipped with a center off hesitation mechanism, which assures that the motor is fully stopped before it can be reversed. Mounts on the enclosure cover and is supplied with a switch seal to maintain watertight integrity.
- C. Run-Stop-Log Switch (P/N 9340)** – Selects speed setting from either main potentiometer or JOG trimpot. Mounts on the enclosure cover and is supplied with a switch seal to maintain watertight integrity.
- D. Signal Isolator KBSI-240D (P/N 9431)** – Provides isolation from non-isolated signal sources. Mounts on the inside of the enclosure cover.
- E. Auto/Manual Switch (P/N 9377)** – When used with the KBSI-240D (P/N 9431), it selects either an isolated signal from the KBSI-240D or from the main speed potentiometer. Mounts on the enclosure cover and is supplied with a switch seal to maintain watertight integrity.
- F. Anti-Plug Reversing Module APRM-PC (P/N 9378A)** – Provides electronic braking and reversing. Mounts on the inside of the enclosure cover.

Note: For use with this control, the APRM-PC must be Revision A or newer.

- G. RFI Filters and Chokes** – RFI Filters and Chokes are available to provide suppression for conducted radio frequency interference (RFI). They comply with the CE Directive 89/336/EEC relating to the EMC Class A Industrial Standard and Class B Residential Standard. See RFI Filters and Chokes Selection Guide (Publication No. D-321).

THE INFORMATION CONTAINED IN THIS DRAWING IS THE SOLE PROPERTY OF THE RANDOLPH AUSTIN CO., ANY REPRODUCTION IN PART OR WHOLE WITHOUT THE WRITTEN PERMISSION OF THE RANDOLPH AUSTIN CO. IS PROHIBITED.

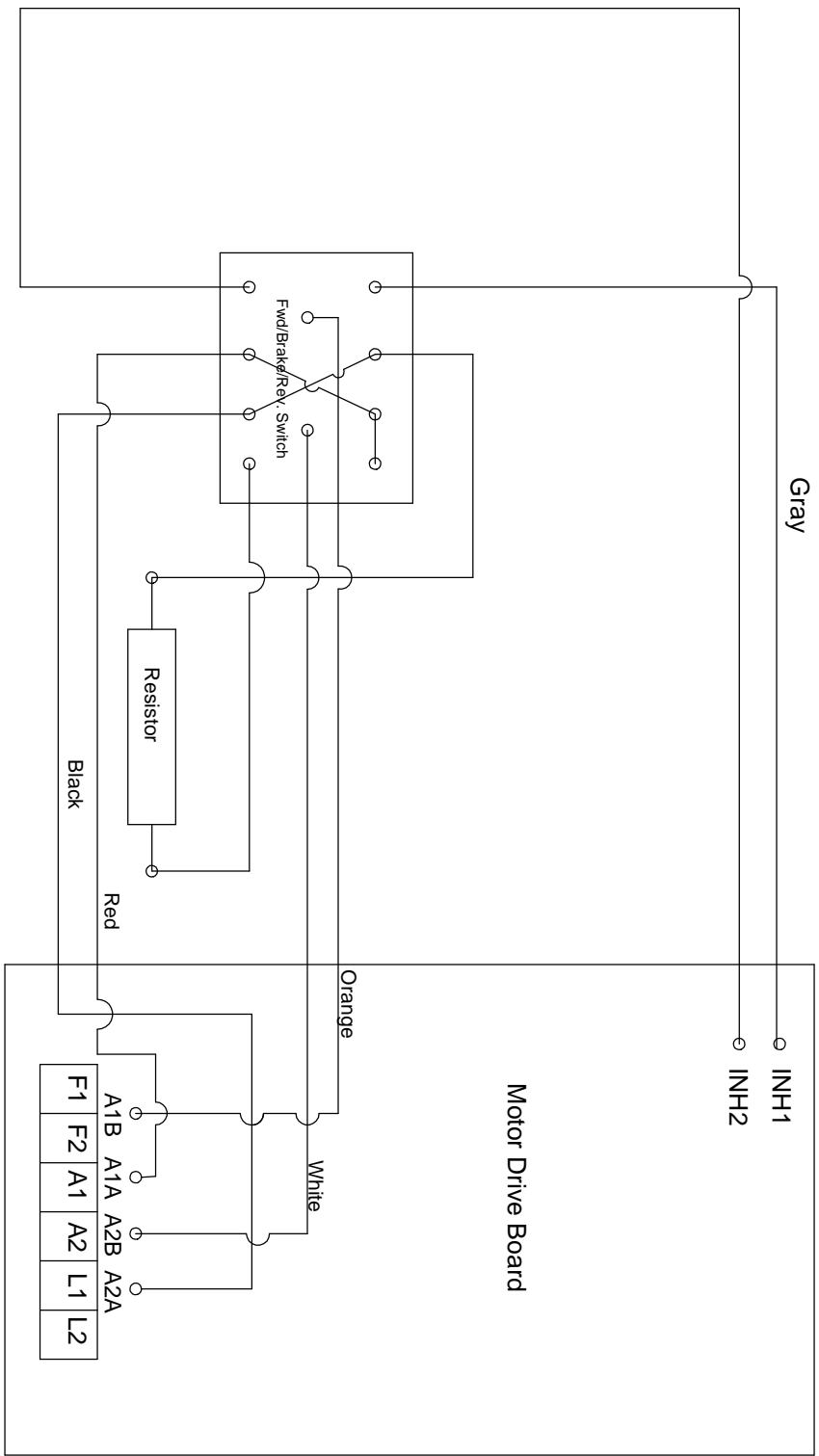

P/N 05-0305 - Fwd/Brake/Reverse Switch

UNLESS OTHERWISE SPECIFIED DIMENSIONAL TOLERANCES ARE: FRACTIONS: DECIMALS: ANGLES		CAD GENERATED DRAWING, DO NOT MANUALLY UPDATE	
MILLIMETERS:	±.1	±1.0°	DATE
INCHES:	±.005	±1.0°	CHECKED
MATERIAL			RESP ENG
FINISH			MFG ENG
APPLICATION	USED ON	DO NOT SCALE DRAWING	QUAL ENG
NEXT ASSY			

Randolph Austin Company
 PO 988 2119 FM 1626 MANCHACA TX.
**Schematic,
 Forward Brake Reverse Switch
 PWM DC speed control**

SIZE	DWG. NO.	REV.
A	05-0300	
SCALE	CAD FILE:	SHEET OF
		1 1

8 THE INFORMATION CONTAINED IN THIS DRAWING IS THE SOLE PROPERTY OF
 7 THE RANDOLPH AUSTIN CO.. ANY REPRODUCTION IN PART OR WHOLE WITHOUT
 6 THE WRITTEN PERMISSION OF THE RANDOLPH AUSTIN CO. IS PROHIBITED.

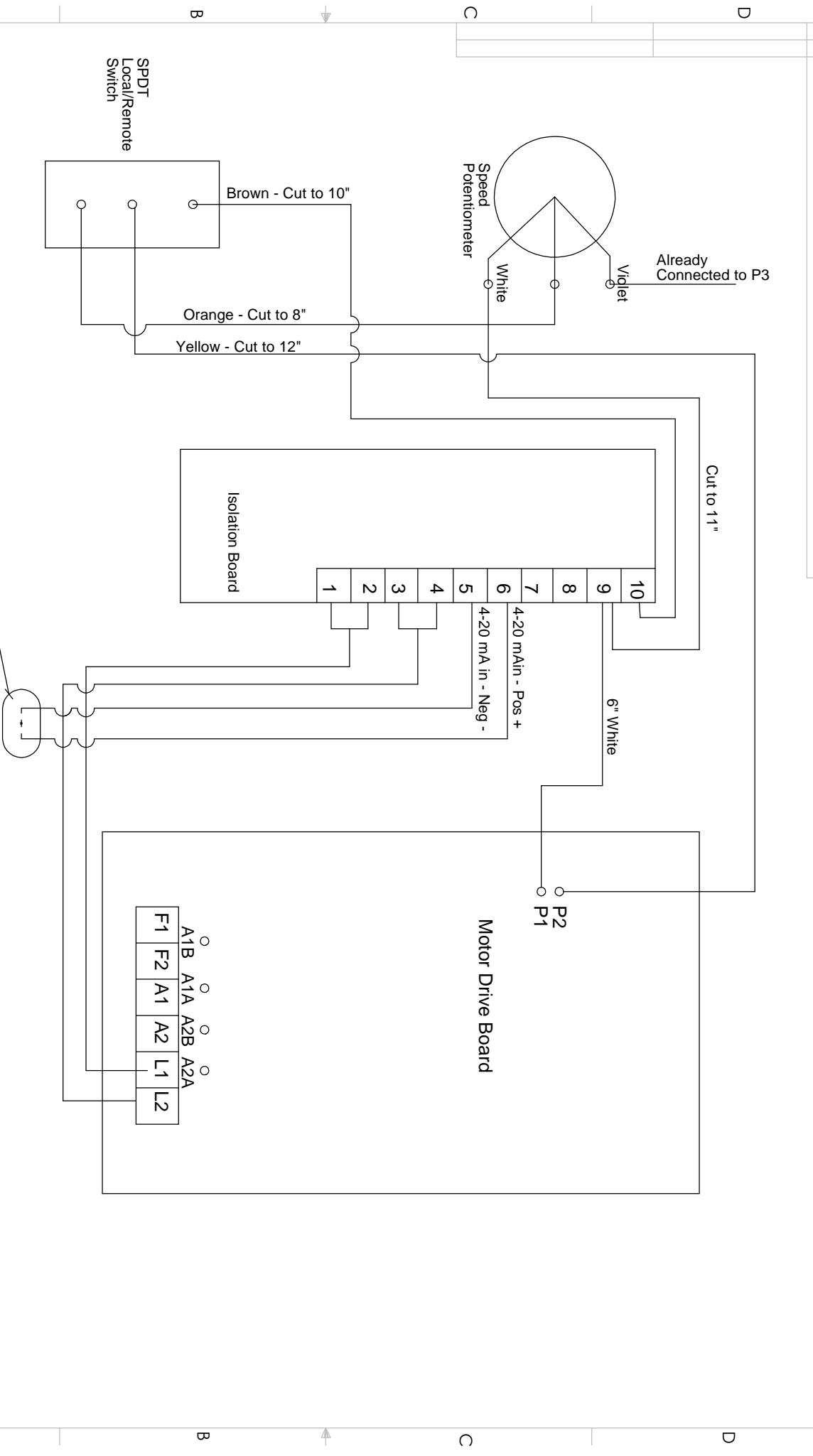

Signal Input

UNLESS OTHERWISE SPECIFIED DIMENSIONAL TOLERANCES ARE: FRACTIONS: DECIMALS: ANGLES: MILLIMETERS:		CAD GENERATED DRAWING, DO NOT MANUALLY UPDATE	
N/A	±.1	±1.0°	DRAWN
INCHES: ±1/64	±.005	±1.0°	CHECKED
MATERIAL			RESP ENG
FINISH			MFG ENG
APPLICATION	USED ON	QUAL ENG	DATE
DO NOT SCALE DRAWING		APPROVALS	
NEXT ASSY		SCALE	
APPLICATION		DWG. NO.	
APPLICATION		05-0301	
APPLICATION		CAD FILE:	
APPLICATION		05-0301	
APPLICATION		SHEET	
APPLICATION		OF	
APPLICATION		REV.	
APPLICATION		REV.	

Randolph Austin Company
 PO 988 2119 FM 1626 MANCHACA TX.

**Isolation Board with
 120 VAC Input**

8 THE INFORMATION CONTAINED IN THIS DRAWING IS THE SOLE PROPERTY OF
7 THE RANDOLPH AUSTIN CO., ANY REPRODUCTION IN PART OR WHOLE WITHOUT
6 THE WRITTEN PERMISSION OF THE RANDOLPH AUSTIN CO. IS PROHIBITED.

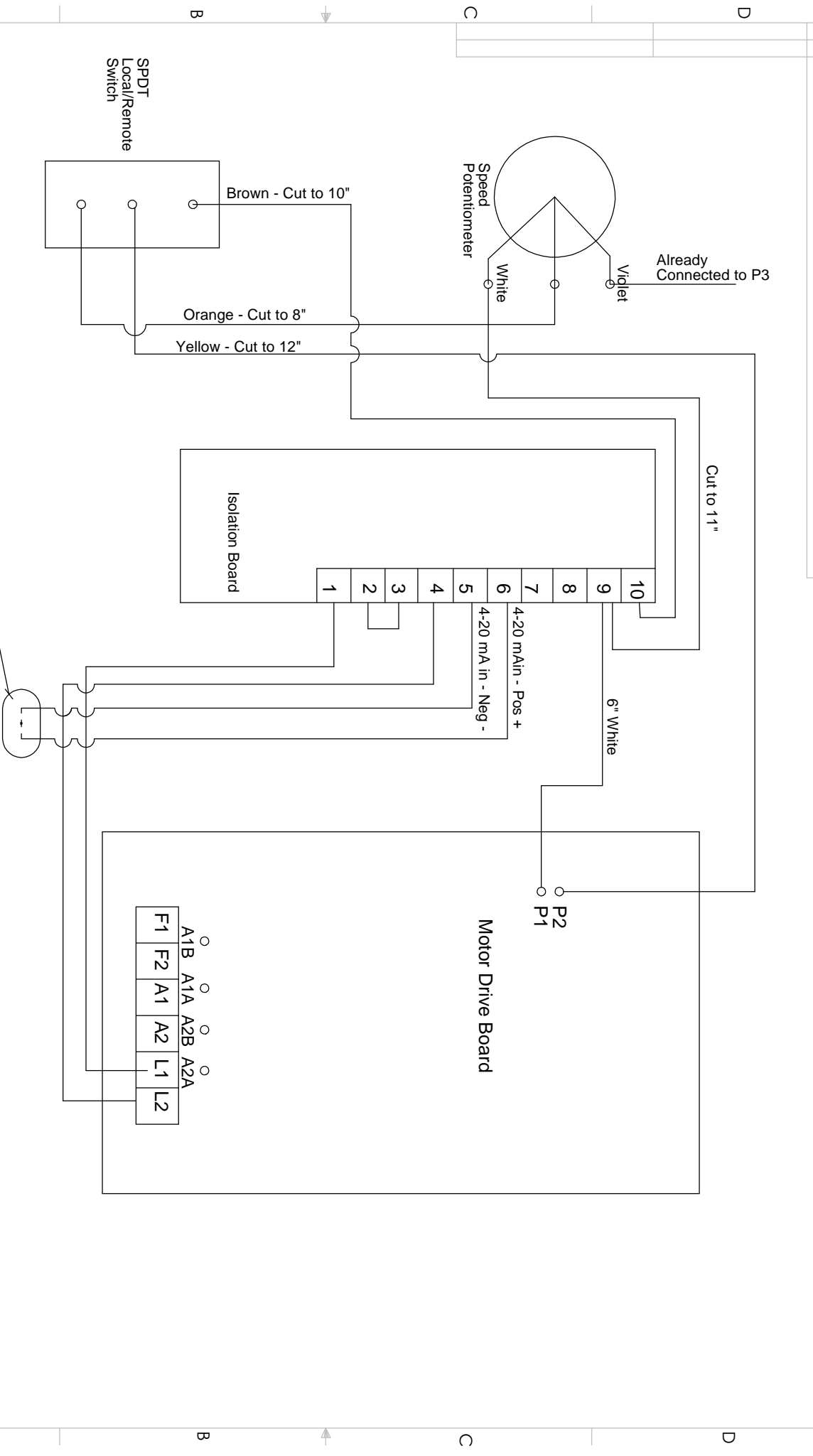

UNLESS OTHERWISE SPECIFIED DIMENSIONAL TOLERANCES ARE: FRACTIONS: DECIMALS: ANGLES: MILLIMETERS: ±.1 ±1.0°		CAD GENERATED DRAWING, DO NOT MANUALLY UPDATE	
INCHES: ±.005 ±1.0°		DRAWN	DATE
MATERIAL		CHECKED	
FINISH		RESP ENG	
MFG ENG			
APPLICATION		QUAL ENG	
NEXT ASSY			
USED ON			
DO NOT SCALE DRAWING			
SCALE		SIZE	DWG. NO.
A		A	05-0302
CAD FILE:		REV.	
		1	
		OF	

Randolph Austin Company
PO 988 2119 FM 1626 MANCHACA TX.

**Isolation Board with
220 VAC Input**

INSTALLATION AND OPERATING INSTRUCTIONS

MODEL KBSI-240D

Signal Isolator KB Part No. 9431

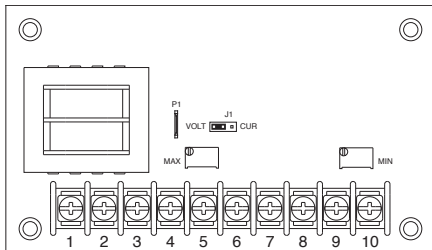

See Safety Warning on Page 1

The information contained in this manual is intended to be accurate. However, the Manufacturer retains the right to make changes in design which may not be included herein.

PENTA KB POWERTM

A COMPLETE LINE OF MOTOR DRIVES

© 2010 KB Electronics, Inc.

TABLE OF CONTENTS

Section	Page
i. Safety Warning	1
I. Introduction	2
II. Mounting	2
III. Wiring	5
IV. Output Signal	9
V. Limited Warranty	14

Tables

1. General Performance Specifications	4
2. Voltage Input Signal	7

Figures

1. Control Layout & Mechanical Specifications	3
2A. 115V Connection	5
2B. 230V Connection	5
3. Current Input Signal Connection	6
4. Voltage Input Signal Connections	7
5A. Leader/Multiple Follower Voltage Following System (Single Main Motor)	9
5B. Leader/Multiple Follower Voltage Following System (Single Main Potentiometer)	9
6A. Leader/Follower Voltage Following System	10
6B. Process Control with Auto/Manual Switch	10
6C. Process Control with Auto (Ratio Pot)/Manual Switch	11
6D. Auto/Manual Operation with Potentiometer on KBSI Input	11

i.   **SAFETY WARNING! Please read carefully:**

This product should be installed and serviced by a qualified technician, electrician, or electrical maintenance person familiar with its operation and the hazards involved. Proper installation, which includes electrical connections, mounting and adequate enclosure, fusing or other current protection, and grounding can reduce the chance of electrical shocks, and/or fires in this product or products used with this product, such as electric motors, switches, coils, solenoids, and/or relays. Do not use this drive in an explosion-proof application. Eye protection must be worn and insulated adjustment tools must be used when working with drive under power. This product is constructed of materials (plastics, metals, carbon, silicon, etc.) which may be a potential hazard. Proper shielding, grounding, and filtering of this product can reduce the emission of radio frequency interference (RFI) which may adversely affect sensitive electronic equipment. The input circuits of this drive may not be isolated from the AC line. Be sure to read and follow all instructions carefully. Fire and/or electrocution can result due to improper use of this product. The drive may contain electronic start/stop circuits, which are used for "Start" and "Stop" functions. However, these circuits are never to be used as safety disconnects since they are not fail-safe. Use only the AC line for this purpose. It is the responsibility of the equipment manufacturer and individual installer to supply this Safety Warning to the ultimate end user of this product. (SW 7/2009)

 This product complies with all CE directives pertinent at the time of manufacture. Contact factory for detailed installation instructions and Declaration of Conformity.

I. INTRODUCTION

The KBSI-240D Signal Isolator is used to isolate, amplify and condition DC voltage and current signals from any source (motors, tachs and transducers) which will drive most variable speed motor controls with a voltage following input. The maximum output voltage of the isolator is 10 volts, which is a linear function of the input signal.

The KBSI-240D is versatile since it can accommodate a wide range of input voltages (0 - 25*, 0 - 120 and 0 - 550V DC) and, in addition, a wide range of input current signals (4 - 20 mA, 10 - 50 mA and 1 - 5 mA). The Voltage/Current ("VLT/CUR") jumper is used to change the KBSI-240D from a voltage to current input.

A built-in power supply enables the KBSI-240D to be controlled with a 5K Ω remote potentiometer (connect potentiometer to terminals "P1," "5" and "6" – see page 9). The potentiometer can also be wired for Auto/Manual Operation.

**The input range of 0 - 25V is the maximum voltage that can be applied to terminals "5" and "6". The minimum input voltage is 0 - 5 volts, which can achieve an output voltage of 0 - 10 volts. The unit is factory calibrated so that a 0 - 10V DC input yields a 0 - 10V DC output.*

II. MOUNTING

Mount the Signal Isolator using (4) 6-32 screws (not included). Use the Control Layout and Mechanical Specifications drawing on page 3 to locate the mounting holes. The unit is designed to be mounted in any position providing its components do not come in contact with grounded or live wiring.

FIGURE 1 – CONTROL LAYOUT & MECHANICAL SPECIFICATIONS (INCHES / [mm])
 (Illustrates Factory Setting of Jumpers and Approximate Trimpot Settings)

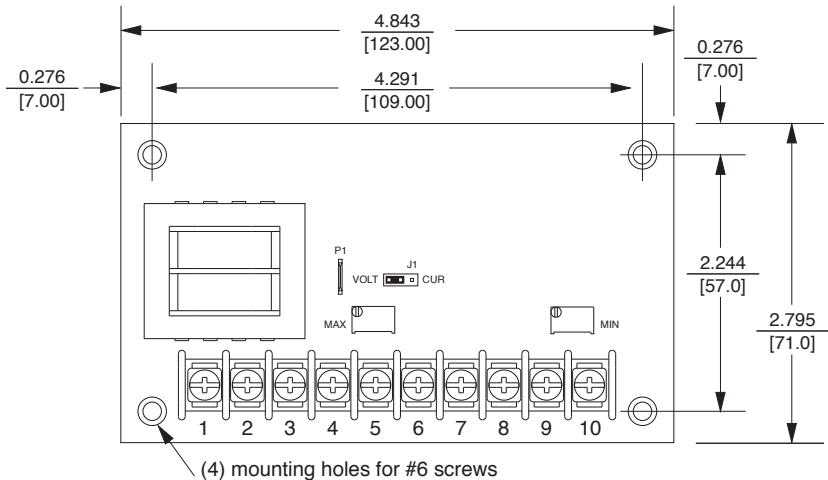

TABLE 1 – GENERAL PERFORMANCE SPECIFICATIONS

AC Power Requirements	115 or 208 - 230V AC, 50/60 Hz (1)
Signal Input Voltage (2)	0 - 25, 0 - 120, 0 - 550V DC
Signal Input Current (2)	1 - 5, 4 - 20, 10 - 50mA (3)
Maximum Output Voltage	10 Volts
Maximum Output Current	10mA
Range of "MIN" Trimpot	± 3 Volts
Range of "MAX" Trimpot	0 to 2 times the input voltage with maximum of 10 Volts
Linearity (4)	± 0.1%
Temperature Drift (4)	4 mV per °C
Operating Temperature Range	0 - 40 °C / 32 - 104 °F

Notes:

1. To achieve full specifications input voltage must be within ± 10% of nominal.
2. Floating (non-grounded) or grounded input signal may be used.
3. See Section III-B-i, on page 6.
4. Specifications are based on an output of 10 volts.

III. WIRING.



Warning! Read Safety Warning on page 1 before attempting to use this control.

Warning! To avoid erratic operation do not bundle AC Line and motor wires with potentiometer, voltage following, enable, inhibit or other signal wiring. Use shielded cables on all signal wiring over 12" (30 cm) – Earth ground the shield on the drive side only.

- A.** AC Power – The KBSI-240D is powered with either 115 or 230V AC, 50/60 Hz by arranging the jumpers between terminals “1” to “4” properly. See figures 2A and 2B. Be sure unit is wired in accordance with the National Electric Code and other codes that may apply. It is recommended that a 1 amp fuse be installed in series with the AC line.
- B.** Input Terminals – A voltage or current signal from a microprocessor, tachometer, transducer, etc. is to be connected to terminals “5” through “8.” The selection of the proper terminal is based on the maximum level of the input signal. See figures 3 and 4.

FIGURE 2A – 115V CONNECTION

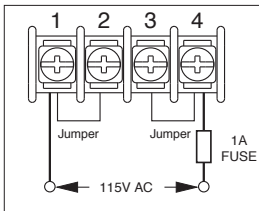
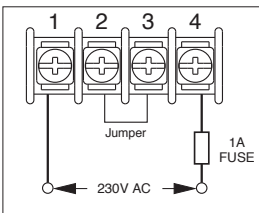

FIGURE 2B – 230V CONNECTION



i. Current Signal Input



Warning! Read Safety Warning on Page 1 before attempting to use this control.

The Signal Isolator accepts 4 – 20 mA DC input to provide 0 – 9 Volts DC output. Connect the current signal input common (–) to Terminal “5” and the positive (+) to Terminal “6”, as shown in Figure 3. Other current signal input ranges can also be used, as described below. Calibrate the Signal Isolator, as described below.

Note: Two resistors, for 10 – 50 mA and 1 – 5 mA inputs, are supplied in the hardware bag included with this kit.

4 – 20 DC Signal Input: No resistor required. Set Jumper J1 in “CUR” position.

10 – 50 mA DC Signal Input (Use Large Resistor with Color Code

“Brown–Green–Brown”): Install the 150Ω – 1W resistor across Terminals

“5” and “6”. Set Jumper J1 in “CUR” position.

1 – 5 mA DC Signal Input (Use Small Resistor with Color Code

“Brown–Black–Red”): Install the 1kΩ – 1/4W resistor across Terminals “5” and “6”. Set Jumper J1 in “VOLT” position.

Procedure to Calibrate the Signal Isolator When Using Current Signal Input:

1. Connect a DC voltmeter (a digital voltmeter is suggested) to Terminals “9” (–) and “10” (+).
2. Apply the minimum signal input current to Terminals “5” (–) and “6” (+).
3. Adjust the MIN Trimpot on the Signal Isolator to obtain an output voltage of 0 Volts DC.
4. Apply the maximum signal input current to Terminals “5” (–) and “6” (+).
5. Adjust the MAX Trimpot on the Signal Isolator to obtain an output voltage of 9 Volts DC.

Notes: **1.** To achieve better accuracy, repeat steps 2 – 5. **2.** If other than 0 Volts DC (minimum) and 9 Volts DC (maximum) is desired, use the MIN and MAX Trimpots on the Signal Isolator to adjust the

6 output to the desired voltages in steps 3 and 5.

**FIGURE 3
CURRENT SIGNAL
INPUT CONNECTION**

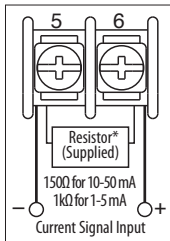

*No resistor required for 4-20 mA.

ii. Voltage Input Signal



Warning! Read Safety Warning on Page 1 before attempting to use this control.

Note: The Voltage/Current (VLT/CUR) jumper must be in the VLT position (factory setting). The KBSI-240D is designed to accept a wide range of input voltage signals as follows:

TABLE 2 – VOLTAGE INPUT SIGNAL

Input Terminals	Minimum Input Voltage Range	Maximum Input Voltage Range
5, 6	0 - 5	0 - 25
5, 7	0 - 25	0 - 120
5, 8	0 - 120	0 - 550

Connect input voltage signal to proper input terminals as indicated in figure 4.

1. Connect a 10V DC meter (digital meter is suggested) to terminals “9” (-) and “10” (+).
2. Apply the maximum input voltage that would be supplied from tach, transducer, etc.
3. Adjust the “MAX” trimpot to the desired output voltage.

Example: A follower motor is to follow the output of a main motor with an armature voltage range of 0 - 90V.

FIGURE 4 – VOLTAGE INPUT SIGNAL CONNECTIONS

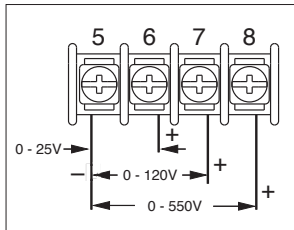

- a) Connect the armature of the main motor to the SI input terminals “5” (-) and “7” (+).
- b) Set the armature voltage of the main motor to zero (0). Adjust the “MIN” trimpot so that the output at terminals “9” and “10” reads zero (0) volts.
- c) Reset the armature voltage of the main motor to 90V. Adjust the “MAX” trimpot so that the output voltage is 9V DC.

Notes:

1. When setting the output voltage using the “MIN” and “MAX” trimpots the voltage or speed of the driven motor can be read directly instead of using the output of the KBSI.
2. When readjusting the “MIN” and “MAX” trimpots, always set the minimum voltage first and then the maximum voltage.
3. Trimpots allow approximately 20 turns for the full range of adjustment. If during the adjustment procedure the output stops changing, try reversing the direction of rotation of trimpot.

IV. OUTPUT SIGNAL

The output signal from the SI is obtained from terminals “9” (-) and “10” (+). Connect the output directly to the signal following input terminal of the speed control. For multiple follower motors, several controls can be driven from a single KBSI-240D. Be sure the AC line connections to the follower control are to the same phase (eg, L1 to L1 and L2 to L2 of all controls.)

The output from the KBSI-240D can be scaled to control the speed control over any desired speed range. Adjust the “MIN” trimpot to provide the desired minimum speed and the “MAX” trimpot to provide the desired maximum speed.

FIGURE 5 – LEADER/MULTIPLE FOLLOWER VOLTAGE FOLLOWING SYSTEM

A) From a Single Main Motor

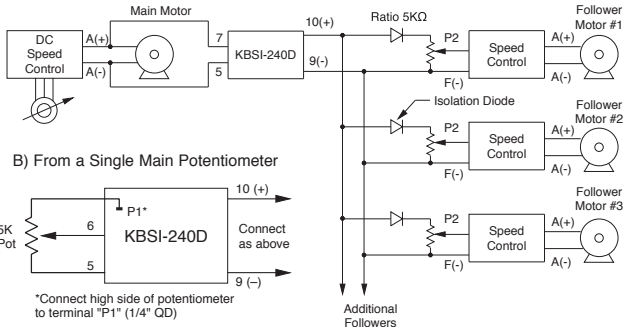

A 10K ratio potentiometer is used to control up to ten (10) follower motors.

If a 5K ratio potentiometer is used, up to five (5) follower motors can be controlled.

B) From a Single Main Potentiometer

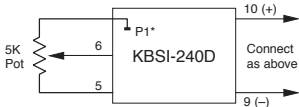

*Connect high side of potentiometer to terminal "P1" (1/4" QD)

Additional Followers

WARNING! If Signal Isolator is connected to multiple speed controls;

- 1) Multiple controls must be powered from the same phase of AC line.
- 2) The positive input terminal to each speed control must be installed with a 1 amp, 600V (1N4005) isolation diode as shown.
- 3) Multiple speed controls can not be used with PWM, Regenerative or Variable Frequency Drives (Inverters).

FIGURE 6A – LEADER/FOLLOWER VOLTAGE FOLLOWING SYSTEM

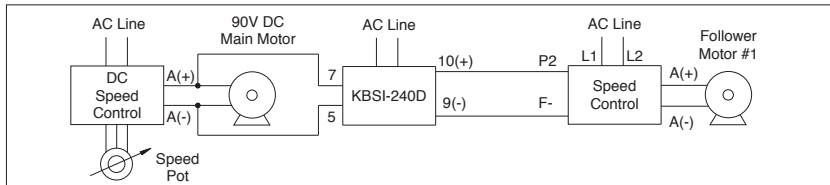

FIGURE 6B – PROCESS CONTROL WITH AUTO/MANUAL SWITCH

The KBSI-240D can be wired in an Auto/Manual mode which will allow manual override of an automatic process. See figure 6B.

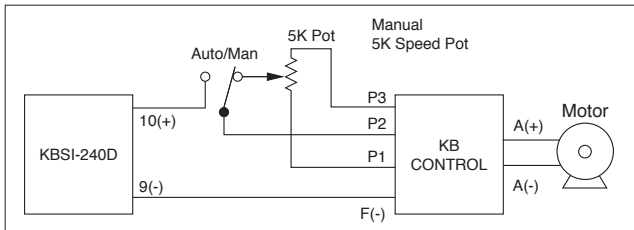

FIGURE 6C – PROCESS CONTROL WITH AUTO (RATIO POT)/MANUAL SWITCH

The following circuit provides for dual purpose usage of the speed pot. In the "AUTO" mode it is used for ratio control and in the "MAN" mode it is used for manual speed adjustment.

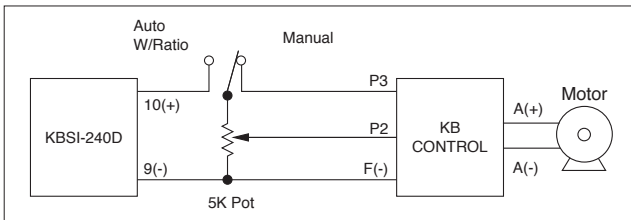
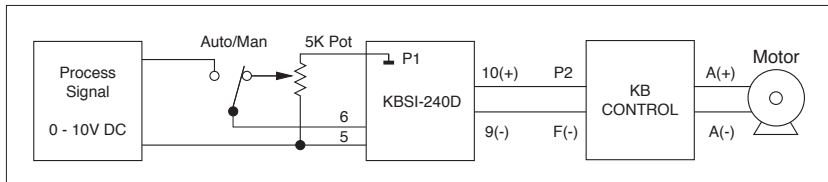

FIGURE 6D – AUTO/MANUAL OPERATION WITH POTENTIOMETER ON KBSI INPUT



Note: The preceding circuit provides for the speed pot to be used in "MAN" mode only. In "AUTO" mode, the process control signal is supplied directly to the signal isolator.

V. LIMITED WARRANTY

For a period of 18 months from the date of original purchase, KB Electronics, Inc. will repair or replace, without charge, devices which our examination proves to be defective in material or workmanship. This warranty is valid if the unit has not been tampered with by unauthorized persons, misused, abused, or improperly installed and has been used in accordance with the instructions and/or ratings supplied. The foregoing is in lieu of any other warranty or guarantee, expressed or implied. KB Electronics, Inc. is not responsible for any expense, including installation and removal, inconvenience, or consequential damage, including injury to any person, caused by items of our manufacture or sale. Some states do not allow certain exclusions or limitations found in this warranty and therefore they may not apply to you. In any event, the total liability of KB Electronics, Inc., under any circumstance, shall not exceed the full purchase price of this product.

(Rev 2/2000)



KB Electronics, Inc.

12095 NW 39th Street, Coral Springs, FL 33065-2516 • (954) 346-4900 • Fax (954) 346-3377
Outside Florida Call TOLL FREE (800) 221-6570 • email – info@kbelectronics.com
www.kbelectronics.com

(A40255) – Rev. E – 9/7/2010

THE INFORMATION CONTAINED IN THIS DRAWING IS THE SOLE PROPERTY OF THE RANDOLPH AUSTIN CO., ANY REPRODUCTION IN PART OR WHOLE WITHOUT THE WRITTEN PERMISSION OF THE RANDOLPH AUSTIN CO. IS PROHIBITED.

Turck Connector
FSV 4.2-0.5

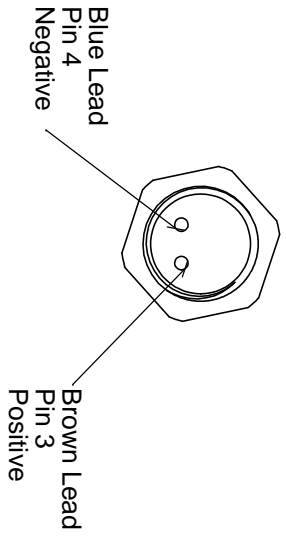

Leads
Internal to control

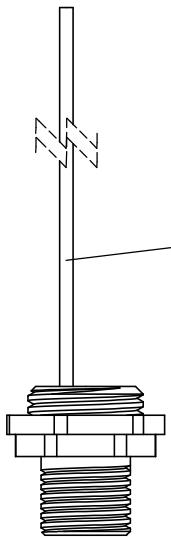

Pins 1 & 2 Not in Use

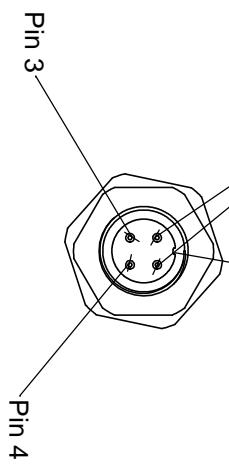

Alignment Key

Alignment Key

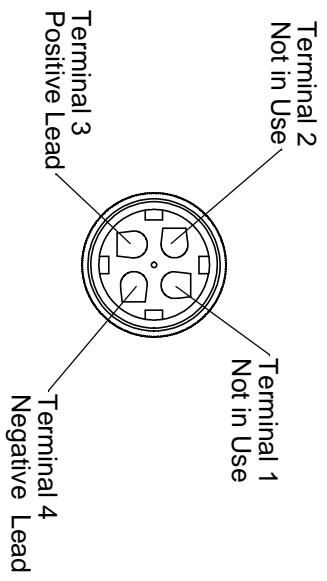
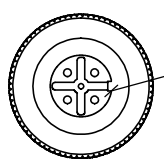
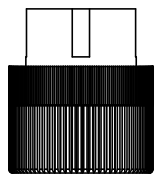

Female Connector
Turck

Only internal Connections Show for Clarity

UNLESS OTHERWISE SPECIFIED, DIMENSIONAL TOLERANCES ARE: FRACTIONS: DECIMALS: ANGLES: MILLIMETERS:		± 1	± 1.0°	CAD GENERATED DRAWING, DO NOT MANUALLY UPDATE	
INCHES:		± 1/64	± .005	± 1.0°	DATE
MATERIAL		FINISH		DRAWN	APPROVALS
MATERIAL		FINISH		CHECKED	DATE
MATERIAL		FINISH		RESP ENG	
MATERIAL		FINISH		MFG ENG	
MATERIAL		FINISH		QUAL ENG	
MATERIAL		FINISH		DO NOT SCALE DRAWING	
MATERIAL		FINISH		APPLICATION	
MATERIAL		FINISH		USED ON	
MATERIAL		FINISH		NEXT ASSY	
MATERIAL		FINISH		APPLICATION	

Randolph Austin Company
PO 988 2119 FM 1626 MANCHACA TX.
Connector
For 4-20 mA input

SIZE DWG. NO. 05-0090 & 05-0091 REV.
A
SCALE CAD FILE: SHEET OF

600 Series Pumps – Flow Curve

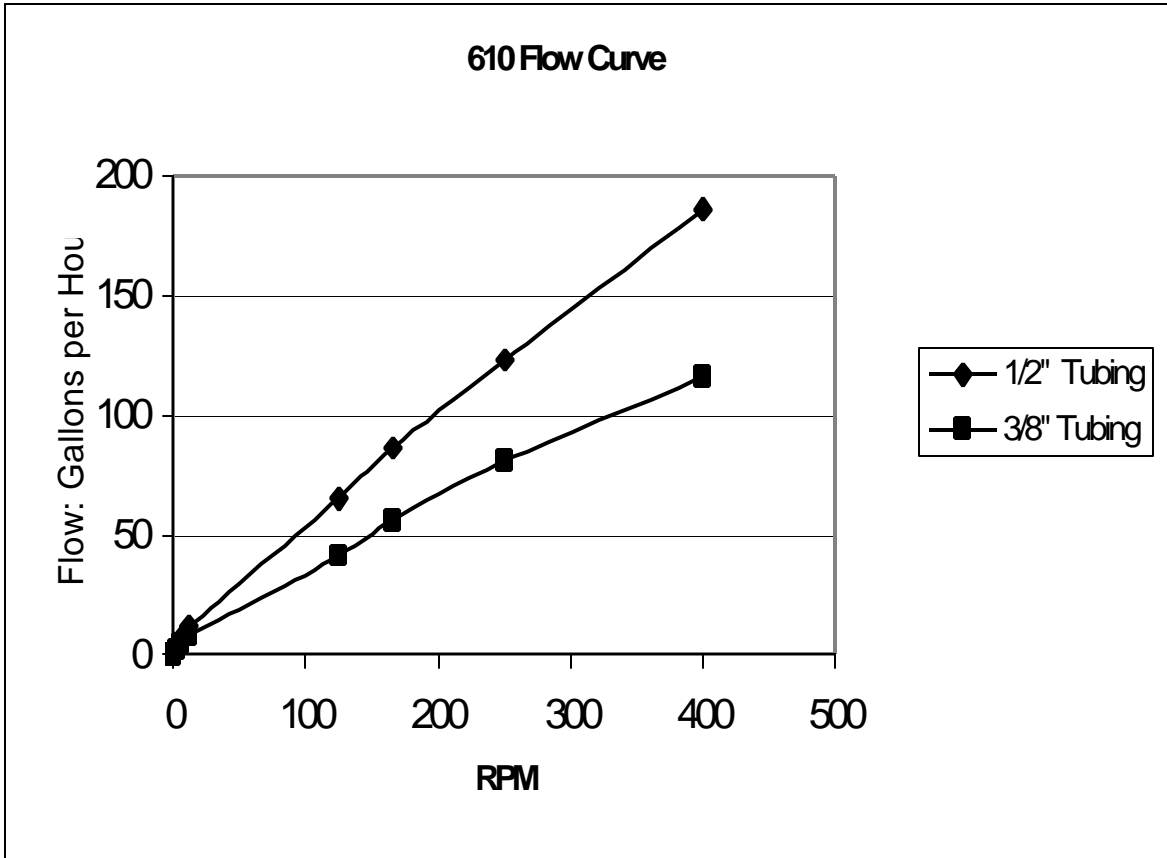

Flow curve established with water and a minimum lifting distance. Flow will be affected by fluid viscosity and lift distance.

HOW TUBING IS INSERTED IN THE PUMP

1. Turn power off. Remove side plate and tubing clamp. Remove existing tubing by manually turning rollers while gently tugging on the tubing.
2. Manually move rollers so that they are horizontal in relation to the base of the pump. Carefully insert tubing through the top tubing clamp section and the top of the pump housing. Manually turn the rotor in a counter clockwise direction until the roller begins to compress the tubing and begin feeding the tubing behind the bottom roller.
3. When the pump has moved $\frac{1}{2}$ turn the tubing should be in a compressed state at the 9:00 o'clock position.
4. Return the side plate and tubing clamp to the pump. Tighten the knurled nuts on the side plate and tube clamp.

Tubing sizes and capacities of the Randolph Pump:

Pump Series	Tubing Size
250	.062" (3/16") ID x .187" (3/16") OD
250	.125" (1/8") ID x .250" (1/4") OD
300	.250" (1/4") ID x .437" (7/16") OD
400	.250" (1/4") ID x .437" (7/16") OD
510	.187" (3/16") ID x .375" (3/8") OD
510	.250" (1/4") ID x .437" (7/16") OD
610, 615, 620	.375" (3/8") ID x .625" (5/8") OD
610, 615, 620	.500" (1/2") ID x .750" (3/4") OD
750	.625" (5/8") ID x .937" (15/16") OD
750	.750" (3/4") ID x 1.062" (1 1/16") OD
880	.750" (3/4") ID x 1.125" (1 1/4") OD
880	1.00" (1") ID x 1.500" (1 1/2") OD

Summary – Physical Properties of Randolph Austin Extruded Tubing

Physical Tubing Properties – ED-Plex™

Specific Gravity	0.98
Tensile Strength(psi)	928
Ultimate Elongation (%)	374
Hardness(Shore 'A' Scale +/- 2)	65
Normal Working Temperature (F)	(-40° to 190°)
Tensile set @ 100%	11.9%
100% Modulus (psi)	386
Compression set(%)	20
Tear Strength(lbs per inch)	103

E-D Plex™ is a multi-purpose tubing that is ideally suited for applications which range from transferring paint, ink, acids and bases. Some oil and hydrocarbons will work with E-D Plex™, but should be tested before use. Combining the environmental resistance of EPDM with the chemical resistance of chloroprene, E-D Plex™ possesses similar elastomeric performance found in more expensive vulcanized rubber, while still maintaining high flex fatigue resistance.. E-D Plex™ has been proven very successful in peristaltic pump applications where continuous flexing is required.

Physical Tubing Properties – Vytex™

Specific Gravity	1.18
Tensile Strength(psi)	1936
Ultimate Elongation (%)	465
Hardness(Shore 'A' Scale +/- 2)	60
Normal Working Temperature (F)	(-34° to 165°)
Tensile set @ 100%	97%
100% Modulus (psi)	484
Compression set(%)	N/A
Tear Strength PPI	115

Vytex™ is a clear flexible polyvinyl tubing ideal for general purpose usage in applications with dilute aqueous solutions (both acids and alkali's) and for food and beverage usage. Strong acid solutions may be used with Vytex™ for short intervals, but should be flushed with water after use. The smooth surface allows for easy flushing and cleanup for food and beverage applications. Vytex™ is a durable, high flex tubing with a Shore "A" durometer of 60 allowing a long life expectancy for continuous flexing where peristaltic pumps are used. Available in lengths up to 500 feet.

Summary – Physical Properties of Randolph Austin Extruded Tubing

Physical Tubing Properties – Cilran™

Specific Gravity	0.90
Tensile Strength(psi)	928
Ultimate Elongation (%)	374
Hardness(Shore 'A' Scale +/- 2)	55
Normal Working Temperature (F)	(-40° to 190°)
Tensile set @ 100%	11.9%
100% Modulus (psi)	20
Compression set(%)	103
Tear Strength(lbs per inch)	386

Cilran™ is made from a thermoplastic elastomer which possesses exceptional chemical resistance to acids and bases. Cilran™ has low gas permeability, good flex fatigue resistance and meets USP Class VI specifications. Ideal for use in many laboratory applications, it may be used in place of silicone for some applications. Cilran™ is translucent white in color and available in lengths up to 500 feet.

Physical Tubing Properties – Prothane II™

Specific Gravity	1.18
Tensile Strength(psi)	2434
Ultimate Elongation (%)	870
Hardness(Shore 'A' Scale +/- 2)	68 A
Normal Working Temperature (F)	
Tensile set @ 100%	7.2%
100% Modulus (psi)	380
Compression set(%)	19
Tear Strength(lbs per inch)	274
Color	Aqua-Blue

PROTHANE II™ is a transparent, aqua blue, polyester polyurethane tubing that exhibits excellent abrasion resistance, has good low temperature properties and is resistant to ozone and oxidation. PROTHANE II™ exhibits an excellent resilience to continuous flexing and impacting experienced in peristaltic pumps. Along with these exceptional features PROTHANE II™ exhibits good hydrolic stability, good oil and fuel resistance and high tensile and tear strength. PROTHANEII™ is resistant to diesel fuel, kerosene, motor oil, mild solvents, aromatic hydrocarbons, gasoline, and concentrated acid and alkaline solutions. The tubing should be tested with the chosen fluid in all cases

Summary – Physical Properties of Randolph Austin Extruded Tubing

Physical Properties – Povinal™

Specific Gravity	1.01
Tensile Strength(psi)	928
Ultimate Elongation (%)	374
Hardness(Shore 'A' Scale +/- 2)	65
Normal Working Temperature (F)	(15° to 125°)
Tensile set @ 100%	11.9%
100% Modulus (psi)	386
Compression set(%)	20
Tear Strength(lbs per inch)	103

Povinal™ is a polyvinyl alcohol based tubing which is excellent for use in applications with aliphatic, aromatic and chlorinated hydrocarbon solvents. Povinal™ has good flex fatigue resistance and is suitable for many industrial applications. It may be used as a substitute for fluoroelastomer polymers in some applications. Not recommended for use with water or solutions containing concentrations of water. Available in lengths up to 500 feet. Pump tubing is teal in color. Transfer tubing is amber.

Randolph Austin Company

Tubing Chemical Resistance Chart

Code indicates the percentage weight gain or loss after 24 hours immersion in the fluid.

(B) Best = 1-4%, (G) Good = 5-10%, (F) Fair = 11- 15%, (P) Poor = 16%+

The data contained herein are based on tests conducted on representative samples and are considered accurate. The results should indicate liquids that could be used with the tubing. However no guarantee is given or implied regarding the application of this data to the safe use of the tubing. It is suggested that the purchaser conduct tests to determine if this material is suited to this application.

	Cilran™	ED-Plex™	Povinal™	Prothane II™	Vytex™
<u>Aqueous Solutions</u>					
Water	B	B	P	B	B
Sodium Chloride (Saturated)	B	B	F	B	B
Aluminum Sulfate	B	B	P	B	B
<u>Acids & Bases</u>					
Sulphuric Acid (66° Be)	B	B	P	G	B
Acetic Acid, Glacial	B	P	P	P	F
Hydrochloric Acid (30° Be)	B	B	P	P	G
Nitric Acid (40° Be)	B	B	P	P	G
Sodium Hydroxide (50% sol.)	B	B	P	B	B
Ammonia Hydroxide	B	B	P	B	B
<u>Aliphatic Hydrocarbons</u>					
Diesel Fuel	P	P	B	G	G
Naptha	P	P	B	G	G
Mineral Oil	P	P	B	G	B
<u>Aromatic Hydrocarbons</u>					
Toluene	P	P	B	P	P
Xylene	P	P	B	P	G
<u>Chlorinated Solvents</u>					
Trichloroethylene	P	P	B	P	P
Carbon Tetrachloride	P	P	B	P	P
Methylene Chloride	P	P	B	P	P
<u>Ketones</u>					
Acetone	B	B	F	P	P
Methyl Ethyl Ketone (MEK)	G	G	F	P	P
<u>Esters</u>					
Amyl Acetate	P	B	F	P	P
Butyl Acetate	P	B	F	P	P
Ethyl Acetate	P	F	F	P	P
<u>Alcohol</u>					
Butyl Alcohol	G	G	P	G	B
Isopropyl Alcohol	G	B	F	B	B
Methyl Alcohol	B	B	F	G	B
Ethyl Alcohol (90%)	B	B	G	G	G
<u>Glycol</u>					
Ethylene Glycol	B	B	G	B	B
Glycerine	B	B	G	B	B
<u>Vegetable Oil</u>					
Safflower Oil	B	B	B	B	G